

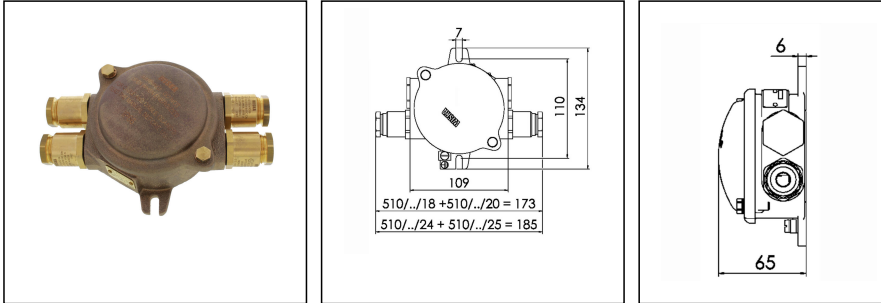

510/4/4x24-Z14

Ex Junction box 134x109x65mm, brass, with terminal block



Products may differ in size, colour and appearance to those shown. If you require further information or customisation, please contact us directly.



WISKA-Order no.	10030257
Type	510/4/4x24-Z14
Material	Brass
Voltage	690 V
Protection class	IP66
Operational areas	Explosion protection
Temp. range min	-55 °C
Temp. range max	130 °C
Material cable gland	Brass
Type of cable gland	M 24 x 1,5
Ø cable diameter min	12 mm
Ø cable diameter max	14,5 mm
Type of cable	armoured
External dimensions LxWxH	134x109x65mm
Mounting	Surface mounting
Rated cross section	6 mm ²
Equipment	Clamp
Terminals/poles	2 x 2-poles, 6mm ²
Explosion Groups	II
Marking	II 2 G Ex eb IIC T6...T4 Gb, II 2 D Ex tb IIIC T85°C Db
Using for cable gland	
Zone	1
Approval	RMRS, DNV-GL
Weight	1,6 kg
Variations	on request

Your Contact:

WISKA India Pvt. Ltd.

Mr. Omkar Ashar · Unit No.247/248,Raheja Tesla Industrial District II , Edison Bldg No.-1A,
Plot No.GEN2/1/C/PART, TTC Industrial Area, MIDC, Juinagar, Navi Mumbai 400705, India

☎ +91-22-4967-1438 · ☎ +91-22-4967-1439 · o.ashar@wiska.in · www.wiska.in

Tariff number

85369010

Equipment:

- 4 contact points to 3x6mm²
- Cable gland M 24x1,5, internal parts Z14
- Position of cable entries is exchangeable

Spare parts**SP-EX-510 terminal block 2x2 pole 6mm²**

22000410

07.07.2026

Your Contact:**WISKA India Pvt. Ltd.**

Mr. Omkar Ashar · Unit No.247/248,Raheja Tesla Industrial District II , Edison Bldg No.-1A,
Plot No.GEN2/1/C/PART, TTC Industrial Area, MIDC, Juinagar, Navi Mumbai 400705, India

☎ +91-22-4967-1438 · ☎ +91-22-4967-1439 · o.ashar@wiska.in · www.wiska.in

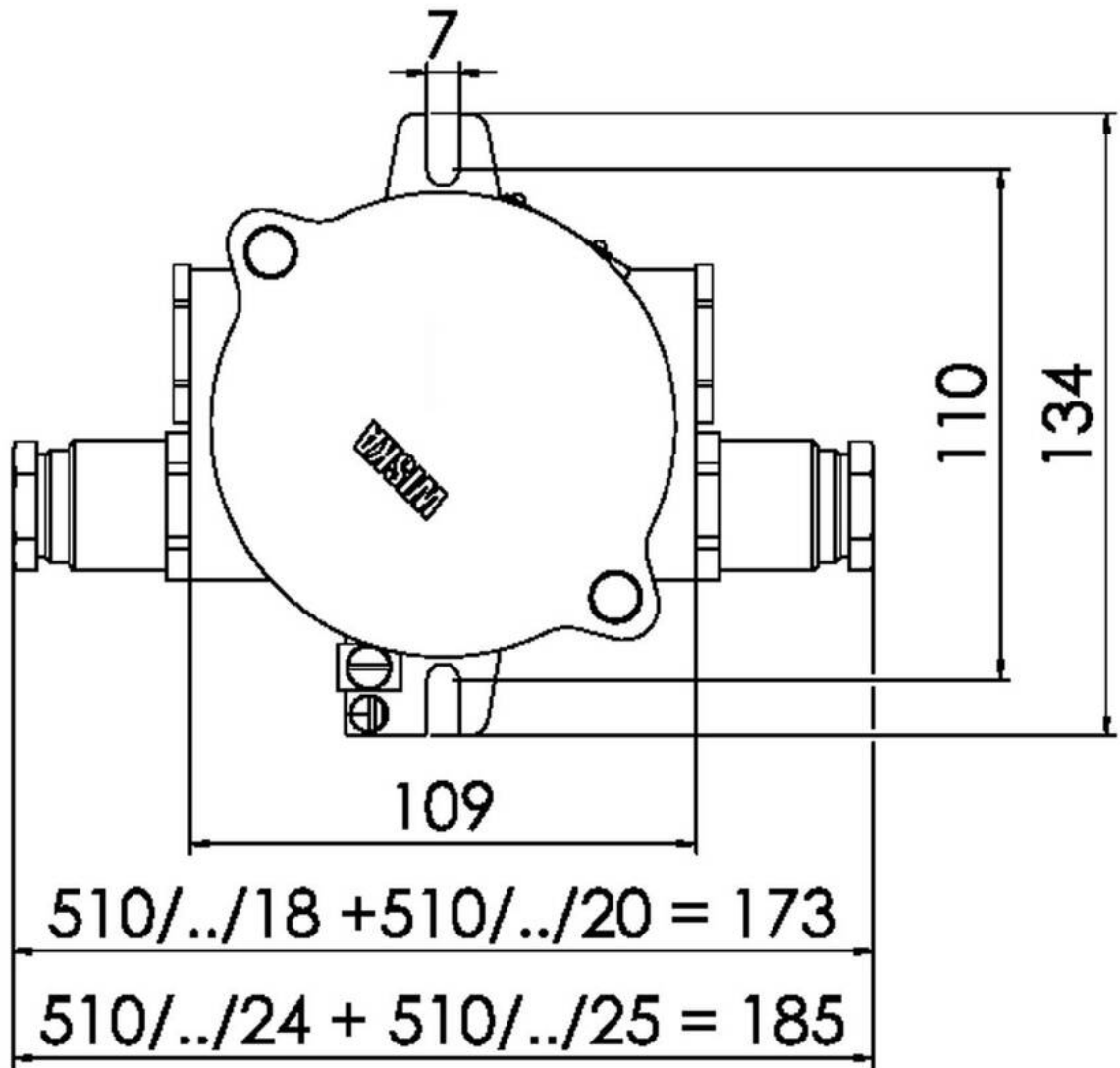

Your Contact:

WISKA India Pvt. Ltd.

Mr. Omkar Ashar · Unit No.247/248,Raheja Tesla Industrial District II , Edison Bldg No.-1A,
Plot No.GEN2/1/C/PART, TTC Industrial Area, MIDC, Juinagar, Navi Mumbai 400705, India

☎ +91-22-4967-1438 · ☎ +91-22-4967-1439 · o.ashar@wiska.in · www.wiska.in

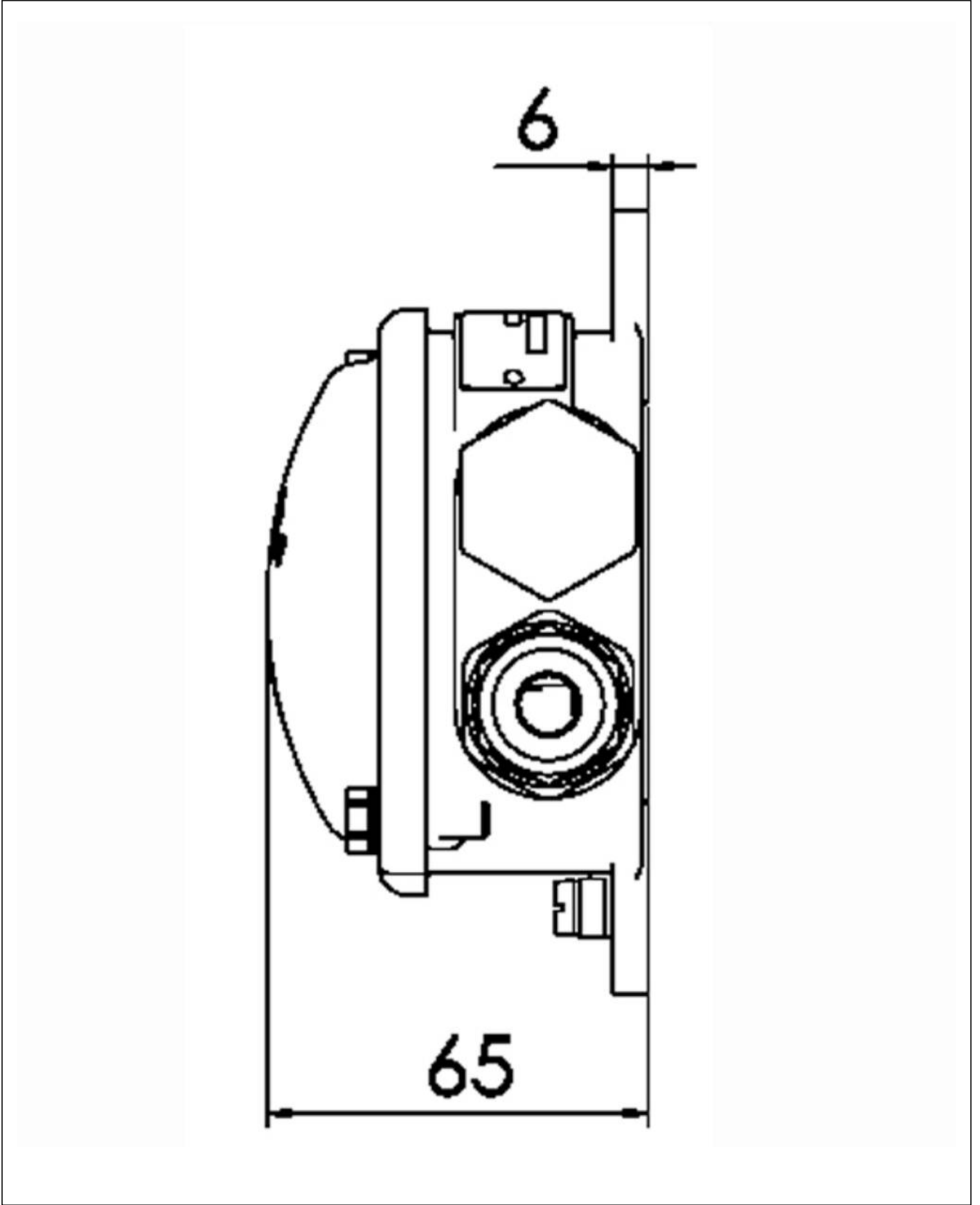

Your Contact:

WISKA India Pvt. Ltd.

Mr. Omkar Ashar · Unit No.247/248,Raheja Tesla Industrial District II , Edison Bldg No.-1A,
Plot No.GEN2/1/C/PART, TTC Industrial Area, MIDC, Juinagar, Navi Mumbai 400705, India

☎ +91-22-4967-1438 · ☎ +91-22-4967-1439 · o.ashar@wiska.in · www.wiska.in