

EVSGS 32 LG

Stop end hexagonal, polyamide, RAL 7035, M32

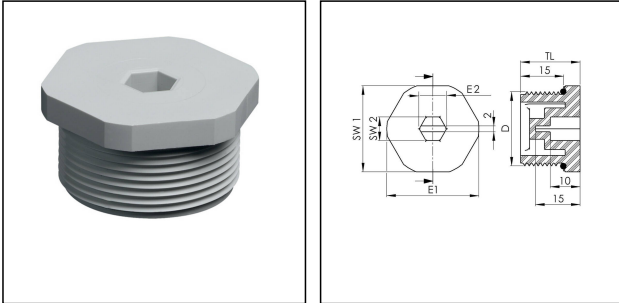

Products may differ in size, colour and appearance to those shown. If you require further information or customisation, please contact us directly.



Material	Polyamide
Temp. range min	-40 °C
Temp. range max	100 °C
Protection class	IP56
Advice	with sealing IP66/IP68
Thread type	M
Ø Connection thread D	32
Lead	1,5
Length screw-in thread L	15 mm
Key width SW1	36 mm
Key width SW2	8 mm
Collar diameter E1	39 mm
Collar diameter E2	9 mm
Total length TL	20 mm
Product Color	RAL 7035
Order no. RAL 7035	10062398
Type	EVSGS 32 LG
Packing unit	100
EAN number	4007685623988
Tariff number	39269097

Recommended accessories

EMUG 32 LG	10060774
-------------------	----------

Your Contact:

WISKA India Pvt. Ltd.

Mr. Omkar Ashar · Unit No.247/248,Raheja Tesla Industrial District II , Edison Bldg No.-1A,
Plot No.GEN2/1/C/PART, TTC Industrial Area, MIDC, Juinagar, Navi Mumbai 400705, India

☎ +91-22-4967-1438 · ☎ +91-22-4967-1439 · o.ashar@wiska.in · www.wiska.in

23.05.2026

Your Contact:

WISKA India Pvt. Ltd.

Mr. Omkar Ashar · Unit No.247/248,Raheja Tesla Industrial District II , Edison Bldg No.-1A,
Plot No.GEN2/1/C/PART, TTC Industrial Area, MIDC, Juinagar, Navi Mumbai 400705, India

☎ +91-22-4967-1438 · ☎ +91-22-4967-1439 · o.ashar@wiska.in · www.wiska.in

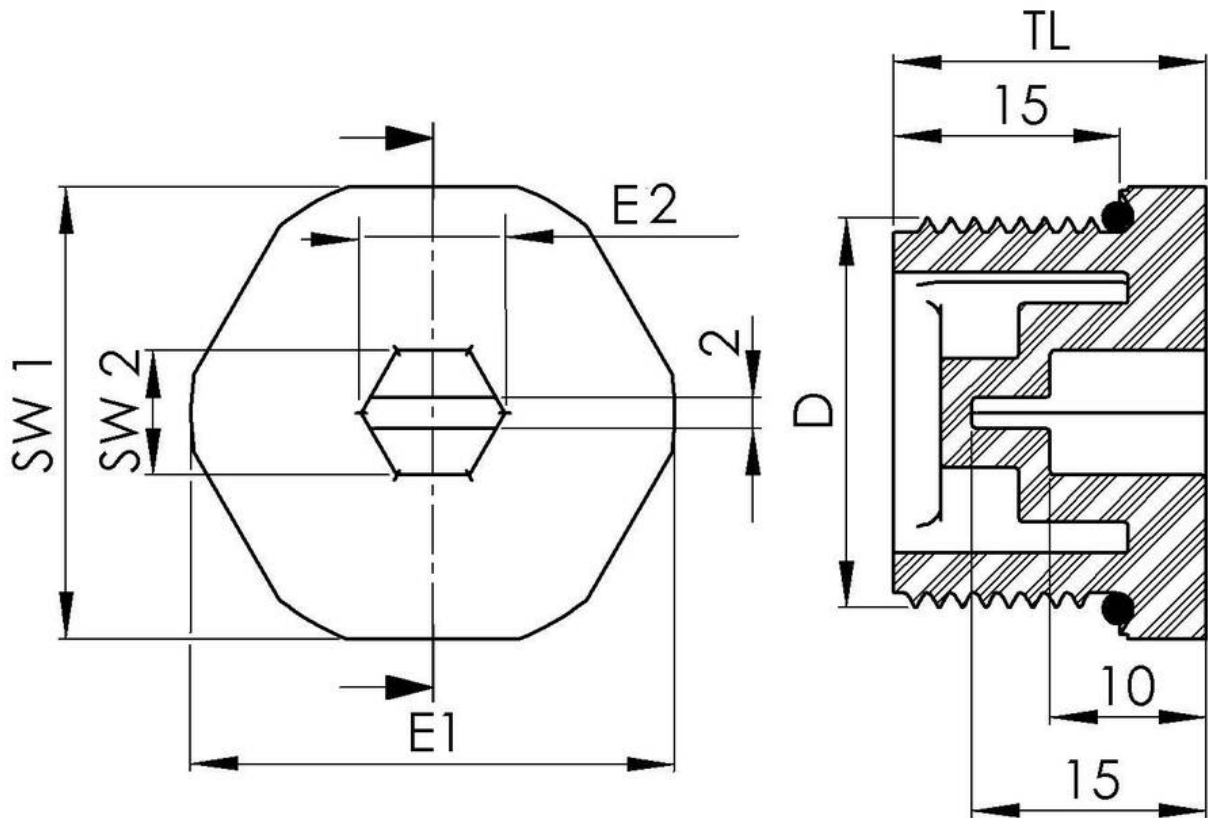

Your Contact:

WISKA India Pvt. Ltd.

Mr. Omkar Ashar · Unit No.247/248,Raheja Tesla Industrial District II , Edison Bldg No.-1A,
Plot No.GEN2/1/C/PART, TTC Industrial Area, MIDC, Juinagar, Navi Mumbai 400705, India

☎ +91-22-4967-1438 · ☎ +91-22-4967-1439 · o.ashar@wiska.in · www.wiska.in

Other technical data on request / subject to change without notice