

ESKV 25

Cable gland, polyamide, M25, RAL 7001 with short thread

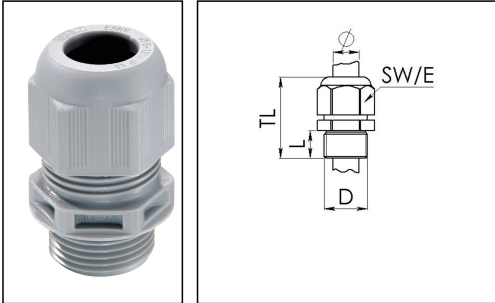

Product illustrations are exemplary and may differ from the chosen product. Further variants and individual customization, we will gladly provide you on request.



Material cable gland	Polyamide
Material sealing gasket	EPDM
Protection class	IP69, IP68 (5 bar 30 min)
Temp. range min	-40 °C
Temp. range max	100 °C
Glow wire test	750 °C
Thread type	M
Ø Connection thread D	25
Lead	1,5
Length screw-in thread L	10 mm
Ø cable diameter min	9 mm
Ø cable diameter max	17 mm
Ø cable diameter UL	10,8 mm - 15,8 mm
Key width SW	29 mm
Collar diameter (E)	32 mm
Total length TL	38 mm - 47 mm
Type of cable anchorage	A
Install. torques fitting	10 N m
Install. torques cap nut	4 N m
Impact category	4
Product Color	RAL 7001
Type	ESKV 25
Order no. RAL 7001	10066383
Packing unit	50
ETIM-Classification	EC000441

Your Contact:

WISKA India Pvt. Ltd.

Mr. Omkar Ashar · 407, V Times Square, Plot No. - 3, Sector - 15, CBD Belapur · Navi Mumbai 400614, India

☎ +91 22/27566438 / 39 · 📠 +91 22/27566441

o.ashar@wiska.in · www.wiska.in

Recommended accessories

MFD 25/02/060	10060452
RDE 25	10060768
MFD 25/02/080	10060952
MFD 25/01/065	10060954
EMUG 25	10062715
EADR 25	10062804
MFD 25/02/070	10063995
BS 17	10064012
MFD 25/03/070	10064342
MFD 25/04/060	10064343
MFD 25/01/090	10101016
MFD 25/01/105-01/055	10101255
MFD 25/05/056	10102023

22.10.2018

Your Contact:

WISKA India Pvt. Ltd.

Mr. Omkar Ashar · 407, V Times Square, Plot No. - 3, Sector - 15, CBD Belapur · Navi Mumbai 400614, India

☎ +91 22/27566438 / 39 · 📠 +91 22/27566441

o.ashar@wiska.in · www.wiska.in



Your Contact:

WISKA India Pvt. Ltd.

Mr. Omkar Ashar · 407, V Times Square, Plot No. - 3, Sector - 15, CBD Belapur · Navi Mumbai 400614, India

☎ +91 22/27566438 / 39 · 📠 +91 22/27566441

o.ashar@wiska.in · www.wiska.in