

## ESSKE-4 12

Ex-cable gland, stainless steel 1.4404, M12

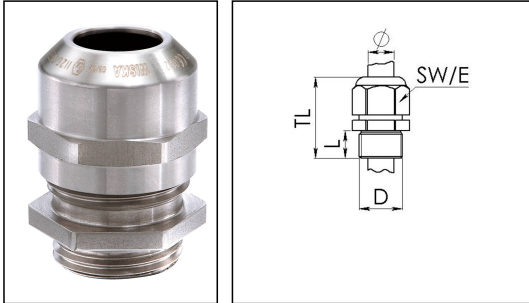

Products may differ in size, colour and appearance to those shown. If you require further information or customisation, please contact us directly.



Material cable gland	Stainless steel A4 (1.4404)
Material clamping cage	Polyamide
Material sealing gasket	EPDM
Temp. range min	-40 °C
Temp. range max	75 °C
Protection class	IP66 / IP68 (5 bar 30 min)
Type of protection	Ex eb, Ex tb
Ex-Certificate	IECEX, ATEX
Thread type	M
Ø Connection thread D	12
Lead	1,5
Length screw-in thread L	5 mm
Ø cable diameter min	4 mm
Ø cable diameter max	7 mm
Key width SW	17 mm
Collar diameter (E)	19 mm
Total length TL	23 mm - 30 mm
Install. torques fitting	4 N m
Install. torques cap nut	4 N m
WISKA-Order no.	10069232
Type	ESSKE-4 12
Packing unit	10
Tariff number	73269098
EAN number	4007685692328
ETIM-Classification	EC000441

Your Contact:

WISKA India Pvt. Ltd.

Mr. Omkar Ashar · Unit No.247/248,Raheja Tesla Industrial District II , Edison Bldg No.-1A,  
Plot No.GEN2/1/C/PART, TTC Industrial Area, MIDC, Juinagar, Navi Mumbai 400705, India

☎ +91-22-4967-1438 · ☎ +91-22-4967-1439 · o.ashar@wiska.in · www.wiska.in

**Recommended accessories**

<b>RDE 12</b>	10062183
<b>BS 7</b>	10064005

27.06.2026

Your Contact:

**WISKA India Pvt. Ltd.**

Mr. Omkar Ashar · Unit No.247/248,Raheja Tesla Industrial District II , Edison Bldg No.-1A,  
Plot No.GEN2/1/C/PART, TTC Industrial Area, MIDC, Juinagar, Navi Mumbai 400705, India

☎ +91-22-4967-1438 · ☎ +91-22-4967-1439 · o.ashar@wiska.in · www.wiska.in



Your Contact:

**WISKA India Pvt. Ltd.**

Mr. Omkar Ashar · Unit No.247/248,Raheja Tesla Industrial District II , Edison Bldg No.-1A,  
Plot No.GEN2/1/C/PART, TTC Industrial Area, MIDC, Juinagar, Navi Mumbai 400705, India

☎ +91-22-4967-1438 · ☎ +91-22-4967-1439 · o.ashar@wiska.in · www.wiska.in

Other technical data on request / subject to change without notice