

ESSVG-4 25 EMV-Z

EMC Pressure compensation cable gland, stainless steel 1.4404, M25

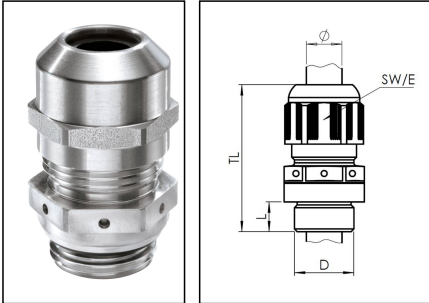

Products may differ in size, colour and appearance to those shown. If you require further information or customisation, please contact us directly.



Material cable gland	Stainless steel A4 (1.4404)
Material membrane	ePTFE
Material sealing gasket	EPDM
Material earthing insert	Brass plated
Airflow at 70mbar	90 l/h
Temp. range min	-40 °C
Temp. range max	100 °C
Protection class	IP68 / IP69
Thread type	M
Ø Connection thread D	25
Lead	1,5
Length screw-in thread L	7 mm
Ø cable diameter min	9 mm
Ø cable diameter max	17 mm
Ø cable below cable shield max	16 mm
Key width SW	30 mm
Collar diameter (E)	33 mm
Install. torques fitting	10 N m
Install. torques cap nut	10 N m
Total length TL	43 mm - 52 mm
WISKA-Order no.	10069507
Type	ESSVG-4 25 EMV-Z
Packing unit	1
EAN number	4007685695077
Tariff number	85369010

Your Contact:

WISKA India Pvt. Ltd.

Mr. Omkar Ashar · Unit No.247/248,Raheja Tesla Industrial District II , Edison Bldg No.-1A,
Plot No.GEN2/1/C/PART, TTC Industrial Area, MIDC, Juinagar, Navi Mumbai 400705, India

☎ +91-22-4967-1438 · ☎ +91-22-4967-1439 · o.ashar@wiska.in · www.wiska.in

ETIM-Classification

EC000441

Recommended accessories



RDE 25	10060768
BS 17	10064012
ESMU 25	10064191

27.06.2026

Your Contact:

WISKA India Pvt. Ltd.

Mr. Omkar Ashar · Unit No.247/248,Raheja Tesla Industrial District II , Edison Bldg No.-1A,
Plot No.GEN2/1/C/PART, TTC Industrial Area, MIDC, Juinagar, Navi Mumbai 400705, India

 +91-22-4967-1438 ·  +91-22-4967-1439 · o.ashar@wiska.in · www.wiska.in



Your Contact:

WISKA India Pvt. Ltd.

Mr. Omkar Ashar · Unit No.247/248,Raheja Tesla Industrial District II , Edison Bldg No.-1A,
Plot No.GEN2/1/C/PART, TTC Industrial Area, MIDC, Juinagar, Navi Mumbai 400705, India

☎ +91-22-4967-1438 · ☎ +91-22-4967-1439 · o.ashar@wiska.in · www.wiska.in

Other technical data on request / subject to change without notice