

ESSVG-4 63 EMV-Z

EMC Pressure compensation cable gland, stainless steel 1.4404, M63

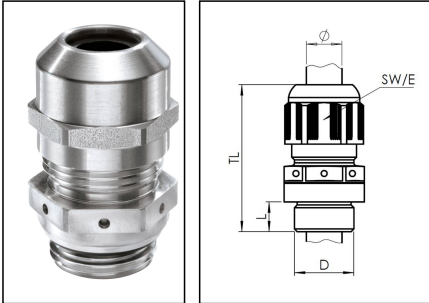

Products may differ in size, colour and appearance to those shown. If you require further information or customisation, please contact us directly.



Material cable gland	Stainless steel A4 (1.4404)
Material membrane	ePTFE
Material sealing gasket	EPDM
Material earthing insert	Brass plated
Airflow at 70mbar	285 l/h
Temp. range min	-40 °C
Temp. range max	100 °C
Protection class	IP68 / IP69
Thread type	M
Ø Connection thread D	63
Lead	1,5
Length screw-in thread L	10 mm
Ø cable diameter min	34 mm
Ø cable diameter max	48 mm
Ø cable below cable shield max	45 mm
Key width SW	68 mm
Collar diameter (E)	75 mm
Install. torques fitting	40 N m
Install. torques cap nut	40 N m
Total length TL	69 mm - 83 mm
WISKA-Order no.	10069511
Type	ESSVG-4 63 EMV-Z
Packing unit	1
EAN number	4007685695114
Tariff number	85369010

Your Contact:

WISKA India Pvt. Ltd.

Mr. Omkar Ashar · Unit No.247/248,Raheja Tesla Industrial District II , Edison Bldg No.-1A,
Plot No.GEN2/1/C/PART, TTC Industrial Area, MIDC, Juinagar, Navi Mumbai 400705, India

☎ +91-22-4967-1438 · ☎ +91-22-4967-1439 · o.ashar@wiska.in · www.wiska.in

ETIM-Classification

EC000441

Recommended accessories



RDE 63	10062189
BS 48	10064019
ESMU 63	10064195

27.06.2026

Your Contact:

WISKA India Pvt. Ltd.

Mr. Omkar Ashar · Unit No.247/248,Raheja Tesla Industrial District II , Edison Bldg No.-1A,
Plot No.GEN2/1/C/PART, TTC Industrial Area, MIDC, Juinagar, Navi Mumbai 400705, India

 +91-22-4967-1438 ·  +91-22-4967-1439 · o.ashar@wiska.in · www.wiska.in



Your Contact:

WISKA India Pvt. Ltd.

Mr. Omkar Ashar · Unit No.247/248,Raheja Tesla Industrial District II , Edison Bldg No.-1A,
Plot No.GEN2/1/C/PART, TTC Industrial Area, MIDC, Juinagar, Navi Mumbai 400705, India

☎ +91-22-4967-1438 · ☎ +91-22-4967-1439 · o.ashar@wiska.in · www.wiska.in

Other technical data on request / subject to change without notice