

## IBS 302008

IBS Industry boxes system 340x206x100mm, stainless steel

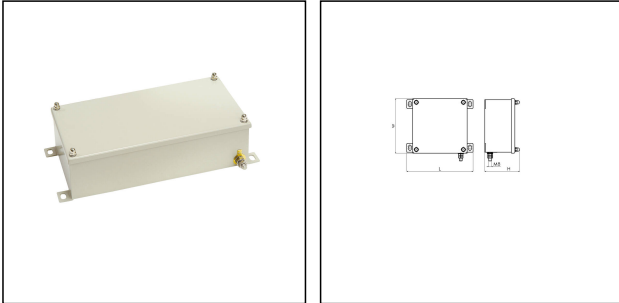

Products may differ in size, colour and appearance to those shown. If you require further information or customisation, please contact us directly.

<b>WISKA-Order no.</b>	10074205
<b>Type</b>	IBS 302008
<b>Protection class</b>	IP66 / IP67
<b>Material</b>	Stainless steel 1.4301 (V2A)
<b>Mounting hole space</b>	322x175mm
<b>External dimensions LxWxH</b>	340x206x100 mm
<b>Internal dimensions LxWxH</b>	280x180x77 mm
<b>Mounting</b>	Surface mounting
<b>Temp. range min</b>	-40 °C
<b>Temp. range max</b>	120 °C
<b>Equipment</b>	none
<b>Terminals/poles</b>	None
<b>Operational areas</b>	Indoor work space, Engine room, Outdoor
<b>Colour</b>	RAL 7032
<b>Weight</b>	2,73 kg
<b>Equipment</b>	Empty and undrilled
<b>Variations</b>	on request
<b>Tariff number</b>	85369010

Remarks:

- Earthing bolts inside and outside
- Indestructible allround cover seal
- Protection specification acc. to EN 50102 (external mechanical impacts): IK 08

### Spare parts

Your Contact:

**WISKA India Pvt. Ltd.**

Mr. Omkar Ashar · Unit No.247/248,Raheja Tesla Industrial District II , Edison Bldg No.-1A,  
Plot No.GEN2/1/C/PART, TTC Industrial Area, MIDC, Juinagar, Navi Mumbai 400705, India

☎ +91-22-4967-1438 · ☎ +91-22-4967-1439 · o.ashar@wiska.in · www.wiska.in

12.05.2026

Your Contact:

**WISKA India Pvt. Ltd.**

Mr. Omkar Ashar · Unit No.247/248,Raheja Tesla Industrial District II , Edison Bldg No.-1A,  
Plot No.GEN2/1/C/PART, TTC Industrial Area, MIDC, Juinagar, Navi Mumbai 400705, India

☎ +91-22-4967-1438 · ☎ +91-22-4967-1439 · o.ashar@wiska.in · www.wiska.in

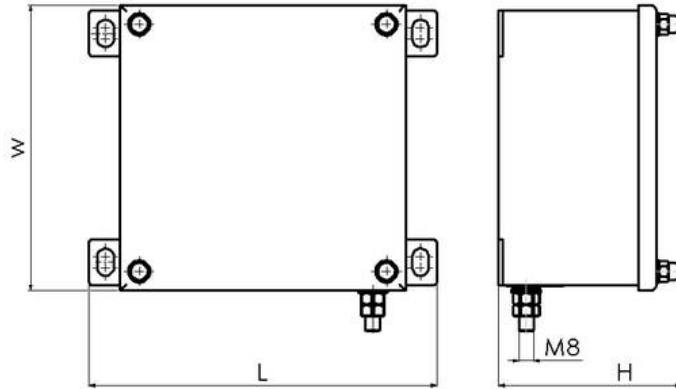

Your Contact:

**WISKA India Pvt. Ltd.**

Mr. Omkar Ashar · Unit No.247/248,Raheja Tesla Industrial District II , Edison Bldg No.-1A,  
Plot No.GEN2/1/C/PART, TTC Industrial Area, MIDC, Juinagar, Navi Mumbai 400705, India

☎ +91-22-4967-1438 · ☎ +91-22-4967-1439 · o.ashar@wiska.in · www.wiska.in