

DIN Rail Kit - COMBI 1210/TS35

DIN Rail Kit for installation of terminals

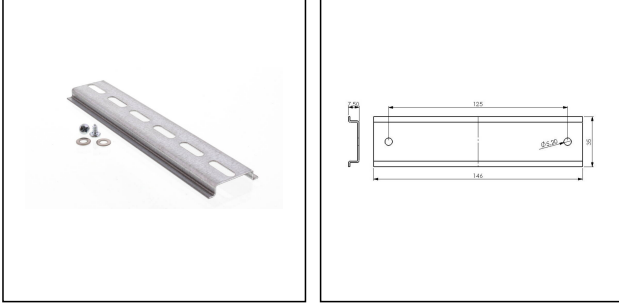

Products may differ in size, colour and appearance to those shown. If you require further information or customisation, please contact us directly.

Material	Steel
Type	DIN Rail Kit - COMBI 1210/TS35
WISKA-Order no.	10101478
Packing unit	1
EAN number	4007685038195
Tariff number	39269097

Remarks:

rail TS35 + fixing material

23.05.2026

Your Contact:

WISKA India Pvt. Ltd.

Mr. Omkar Ashar · Unit No.247/248,Raheja Tesla Industrial District II , Edison Bldg No.-1A,
Plot No.GEN2/1/C/PART, TTC Industrial Area, MIDC, Juinagar, Navi Mumbai 400705, India

☎ +91-22-4967-1438 · ☎ +91-22-4967-1439 · o.ashar@wiska.in · www.wiska.in

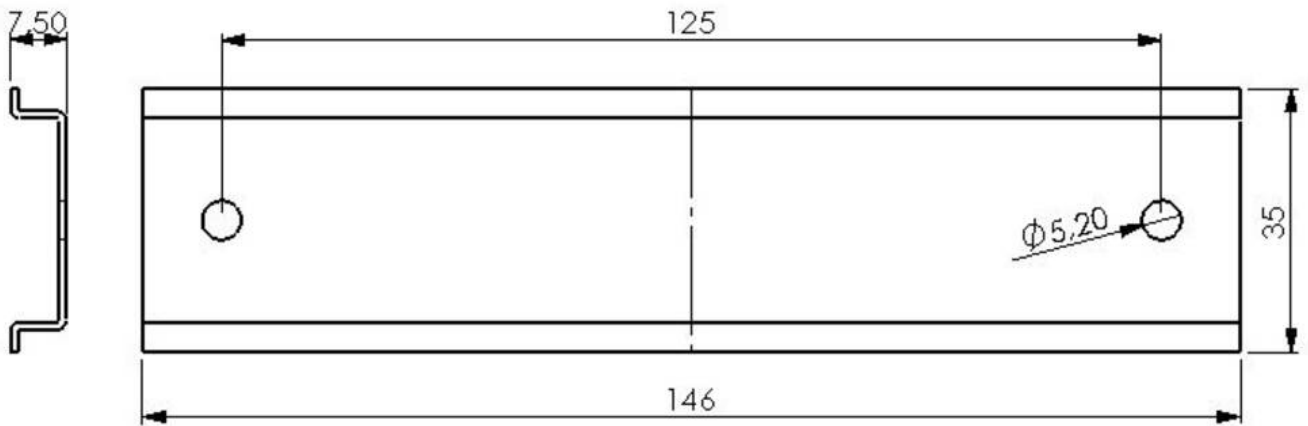

Your Contact:

WISKA India Pvt. Ltd.

Mr. Omkar Ashar · Unit No.247/248,Raheja Tesla Industrial District II , Edison Bldg No.-1A,
Plot No.GEN2/1/C/PART, TTC Industrial Area, MIDC, Juinagar, Navi Mumbai 400705, India

☎ +91-22-4967-1438 · ☎ +91-22-4967-1439 · o.ashar@wiska.in · www.wiska.in