

EMMU 75

Locknut, brass nickel-plated, M75

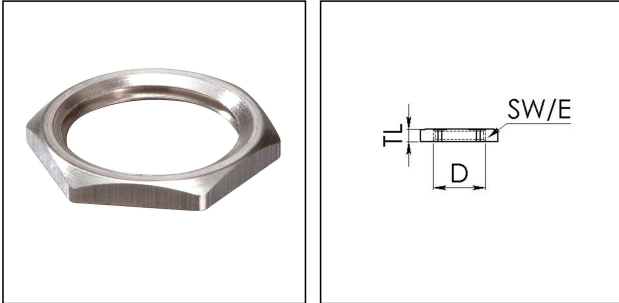

Products may differ in size, colour and appearance to those shown. If you require further information or customisation, please contact us directly.



| | |
|--------------------------------|---------------------|
| Material | Brass nickel-plated |
| Surface | Nickel-plated |
| Temp. range min | -200 °C |
| Temp. range max | 250 °C |
| Thread type | M |
| Ø Connection thread D | 75 |
| Lead | 1,5 |
| Key width SW | 80 mm |
| Collar diameter (E) | 89 mm |
| Total length TL | 8 mm |
| Order no. nickel-plated | 10101777 |
| Type | EMMU 75 |
| Packing unit | 1 |
| EAN number | 4007685041119 |
| Tariff number | 74153300 |
| ETIM-Classification | EC000940 |

23.05.2026

Your Contact:

WISKA India Pvt. Ltd.

Mr. Omkar Ashar · Unit No.247/248,Raheja Tesla Industrial District II , Edison Bldg No.-1A,
Plot No.GEN2/1/C/PART, TTC Industrial Area, MIDC, Juinagar, Navi Mumbai 400705, India

☎ +91-22-4967-1438 · ☎ +91-22-4967-1439 · o.ashar@wiska.in · www.wiska.in



Your Contact:

WISKA India Pvt. Ltd.

Mr. Omkar Ashar · Unit No.247/248,Raheja Tesla Industrial District II , Edison Bldg No.-1A,
Plot No.GEN2/1/C/PART, TTC Industrial Area, MIDC, Juinagar, Navi Mumbai 400705, India

☎ +91-22-4967-1438 · ☎ +91-22-4967-1439 · o.ashar@wiska.in · www.wiska.in