

EMSKE 25 EMV-S

Ex-EMC cable gland with contact spring insert, brass nickel-plated, M25

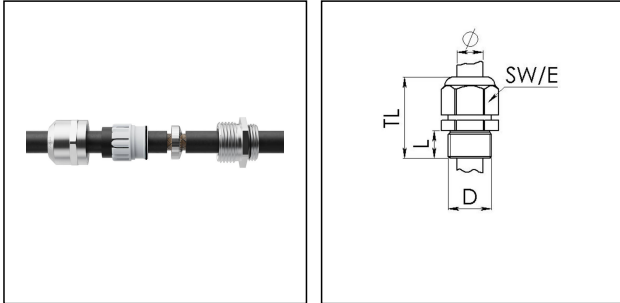

Products may differ in size, colour and appearance to those shown. If you require further information or customisation, please contact us directly.



Material cable gland	Brass nickel-plated
Material clamping cage	Polyamide
Material sealing gasket	EPDM
Material earthing insert	Stainless steel 1.4310
Temp. range min	-40 °C
Temp. range max	75 °C
Protection class	IP66 / IP68 (5 bar 30 min)
Type of protection	Ex tb, Ex eb
Ex-Certificate	ATEX, IECEx
Thread type	M
Ø Connection thread D	25
Lead	1,5
Length screw-in thread L	7 mm
Ø cable diameter min	10 mm
Ø cable diameter max	17 mm
Ø cable below cable shield max	16 mm
Key width SW	29 mm
Collar diameter (E)	32 mm
Total length TL	33 mm - 42 mm
Install. torques fitting	10 N m
Install. torques cap nut	10 N m
Surface	Nickel-plated
Order no. nickel-plated	10102974
Type	EMSKE 25 EMV-S
Packing unit	50

Your Contact:

WISKA India Pvt. Ltd.

Mr. Omkar Ashar · Unit No.247/248,Raheja Tesla Industrial District II , Edison Bldg No.-1A,
Plot No.GEN2/1/C/PART, TTC Industrial Area, MIDC, Juinagar, Navi Mumbai 400705, India

+91-22-4967-1438 · +91-22-4967-1439 · o.ashar@wiska.in · www.wiska.in

Tariff number	85369010
EAN number	4007685076067

Recommended accessories

RDE 25	10060768
EMMU-EMV 25	10063213
BS 17	10064012

27.06.2026

Your Contact:

WISKA India Pvt. Ltd.

Mr. Omkar Ashar · Unit No.247/248,Raheja Tesla Industrial District II , Edison Bldg No.-1A,
Plot No.GEN2/1/C/PART, TTC Industrial Area, MIDC, Juinagar, Navi Mumbai 400705, India

☎ +91-22-4967-1438 · ☎ +91-22-4967-1439 · o.ashar@wiska.in · www.wiska.in



Your Contact:

WISKA India Pvt. Ltd.

Mr. Omkar Ashar · Unit No.247/248,Raheja Tesla Industrial District II , Edison Bldg No.-1A,
Plot No.GEN2/1/C/PART, TTC Industrial Area, MIDC, Juinagar, Navi Mumbai 400705, India

☎ +91-22-4967-1438 · ☎ +91-22-4967-1439 · o.ashar@wiska.in · www.wiska.in

Other technical data on request / subject to change without notice