

ESKE/1S-L-e 20

Ex-cable gland, polyamide with flex protection, RAL 9005, M20

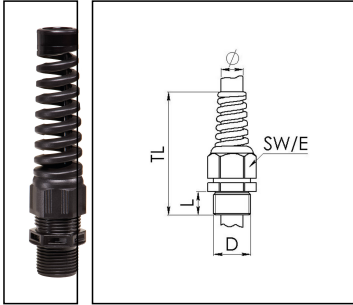

Products may differ in size, colour and appearance to those shown. If you require further information or customisation, please contact us directly.



Material cable gland	Polyamide
Material sealing gasket	EPDM
Temp. range min	-40 °C
Temp. range max	75 °C
Protection class	IP66 / IP68 (5 bar 30 min)
Type of protection	Ex eb, Ex tb
Ex-Certificate	IECEx, ATEX
Glow wire test	750 °C
Thread type	M
Ø Connection thread D	20
Lead	1,5
Length screw-in thread L	15 mm
Ø cable diameter min	7 mm
Ø cable diameter max	13 mm
Key width SW	24 mm
Collar diameter (E)	27 mm
Total length TL	108 mm - 117 mm
Equipment	Incl. connection thread gasket
Product Color	RAL 9005
Order no. RAL 9005	10103505
Type	ESKE/1S-L-e 20
Packing unit	25
EAN number	4007686285123
Tariff number	39269097
ETIM-Classification	EC000441

Your Contact:

WISKA India Pvt. Ltd.

Mr. Omkar Ashar · Unit No.247/248,Raheja Tesla Industrial District II , Edison Bldg No.-1A,
Plot No.GEN2/1/C/PART, TTC Industrial Area, MIDC, Juinagar, Navi Mumbai 400705, India

☎ +91-22-4967-1438 · ☎ +91-22-4967-1439 · o.ashar@wiska.in · www.wiska.in

Recommended accessories

EMUG 20 BK	10061782
RDE 20	10062185
BS 13	10064010

12.05.2026

Your Contact:

WISKA India Pvt. Ltd.

Mr. Omkar Ashar · Unit No.247/248,Raheja Tesla Industrial District II , Edison Bldg No.-1A,
Plot No.GEN2/1/C/PART, TTC Industrial Area, MIDC, Juinagar, Navi Mumbai 400705, India

☎ +91-22-4967-1438 · ☎ +91-22-4967-1439 · o.ashar@wiska.in · www.wiska.in



Your Contact:

WISKA India Pvt. Ltd.

Mr. Omkar Ashar · Unit No.247/248,Raheja Tesla Industrial District II , Edison Bldg No.-1A,
Plot No.GEN2/1/C/PART, TTC Industrial Area, MIDC, Juinagar, Navi Mumbai 400705, India

☎ +91-22-4967-1438 · ☎ +91-22-4967-1439 · o.ashar@wiska.in · www.wiska.in

Other technical data on request / subject to change without notice