

DIN Rail Kit - COMBI 407/TS 15

DIN Rail Kit for installation of terminals

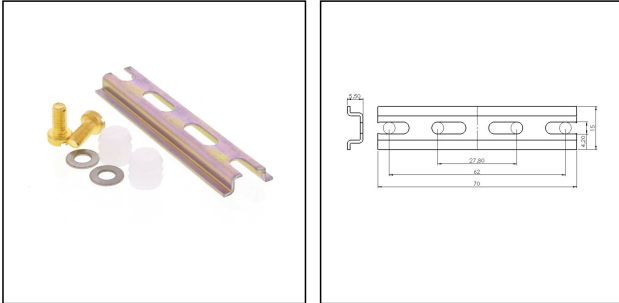

Products may differ in size, colour and appearance to those shown. If you require further information or customisation, please contact us directly.

Material	Steel
Type	DIN Rail Kit - COMBI 407/TS 15
WISKA-Order no.	10105604
Packing unit	1
EAN number	4007686010886
Tariff number	39269097

Remarks:

Rail TS 15 + fixing material

12.05.2026

Your Contact:

WISKA India Pvt. Ltd.

Mr. Omkar Ashar · Unit No.247/248,Raheja Tesla Industrial District II , Edison Bldg No.-1A,
Plot No.GEN2/1/C/PART, TTC Industrial Area, MIDC, Juinagar, Navi Mumbai 400705, India

☎ +91-22-4967-1438 · ☎ +91-22-4967-1439 · o.ashar@wiska.in · www.wiska.in

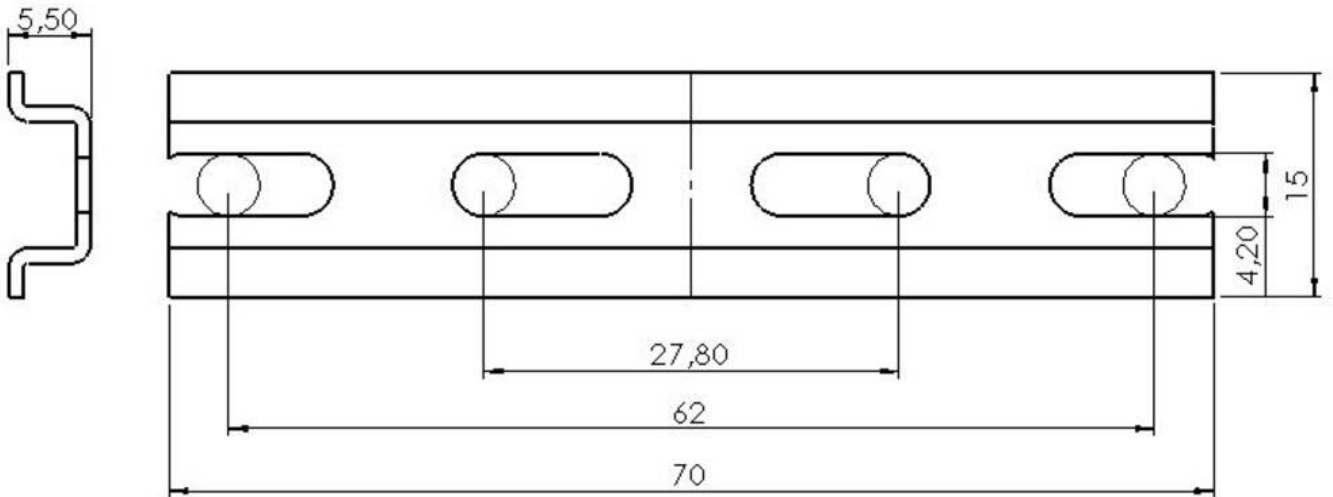

Your Contact:

WISKA India Pvt. Ltd.

Mr. Omkar Ashar · Unit No.247/248,Raheja Tesla Industrial District II , Edison Bldg No.-1A,
Plot No.GEN2/1/C/PART, TTC Industrial Area, MIDC, Juinagar, Navi Mumbai 400705, India

☎ +91-22-4967-1438 · ☎ +91-22-4967-1439 · o.ashar@wiska.in · www.wiska.in