

ESSVG 25 LT RW

Railway pressure compensation cable gland, LowTemp, stainless steel, M25

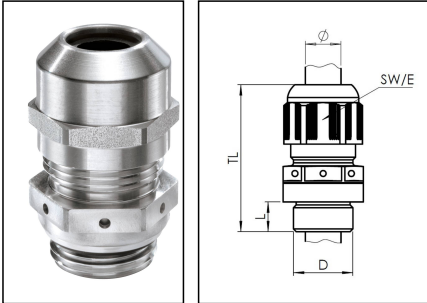

Products may differ in size, colour and appearance to those shown. If you require further information or customisation, please contact us directly.



Material cable gland	Edelstahl A2 (1.4305)
Material sealing gasket	Silicone
Material clamping cage	Polyamide UL94-V0
Material membrane	ePTFE
Airflow at 70mbar	90 l/h
Protection class	IP68
Thread type	M
Ø Connection thread D	25
Lead	1,5
Length screw-in thread L	7 mm
Temp. range min	-60 °C
Temp. range max	100 °C
Ø cable diameter min	9 mm
Ø cable diameter max	17 mm
Key width SW	30 mm
Collar diameter (E)	33 mm
Total length TL	43 mm - 52 mm
Install. torques fitting	10 N m
Install. torques cap nut	10 N m
WISKA-Order no.	10105910
Type	ESSVG 25 LT RW
Packing unit	1
EAN number	4007686013726
Tariff number	73269098
ETIM-Classification	EC000441

Your Contact:

WISKA India Pvt. Ltd.

Mr. Omkar Ashar · Unit No.247/248,Raheja Tesla Industrial District II , Edison Bldg No.-1A,
Plot No.GEN2/1/C/PART, TTC Industrial Area, MIDC, Juinagar, Navi Mumbai 400705, India

☎ +91-22-4967-1438 · ☎ +91-22-4967-1439 · o.ashar@wiska.in · www.wiska.in

Recommended accessories

RDE 25 LT	10063910
BS 17	10064012
ESMU 25	10064191
ORD-S 25	10101760

24.06.2026

Your Contact:

WISKA India Pvt. Ltd.

Mr. Omkar Ashar · Unit No.247/248,Raheja Tesla Industrial District II , Edison Bldg No.-1A,
Plot No.GEN2/1/C/PART, TTC Industrial Area, MIDC, Juinagar, Navi Mumbai 400705, India

☎ +91-22-4967-1438 · ☎ +91-22-4967-1439 · o.ashar@wiska.in · www.wiska.in



Your Contact:

WISKA India Pvt. Ltd.

Mr. Omkar Ashar · Unit No.247/248, Raheja Tesla Industrial District II , Edison Bldg No.-1A,
Plot No.GEN2/1/C/PART, TTC Industrial Area, MIDC, Juinagar, Navi Mumbai 400705, India

☎ +91-22-4967-1438 · ☎ +91-22-4967-1439 · o.ashar@wiska.in · www.wiska.in

Other technical data on request / subject to change without notice