

ESSVG 40 LT RW

Railway pressure compensation cable gland, LowTemp, stainless steel, M40

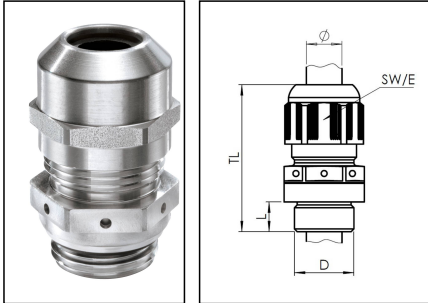

Products may differ in size, colour and appearance to those shown. If you require further information or customisation, please contact us directly.



Material cable gland	Edelstahl A2 (1.4305)
Material sealing gasket	Silicone
Material clamping cage	Polyamide UL94-V0
Material membrane	ePTFE
Airflow at 70mbar	150 l/h
Protection class	IP68
Thread type	M
Ø Connection thread D	40
Lead	1,5
Length screw-in thread L	8 mm
Temp. range min	-60 °C
Temp. range max	100 °C
Ø cable diameter min	16 mm
Ø cable diameter max	28 mm
Key width SW	46 mm
Collar diameter (E)	50 mm
Total length TL	57 mm - 70 mm
Install. torques fitting	20 N m
Install. torques cap nut	20 N m
WISKA-Order no.	10105912
Type	ESSVG 40 LT RW
Packing unit	1
EAN number	4007686013740
Tariff number	73269098
ETIM-Classification	EC000441

Your Contact:

WISKA India Pvt. Ltd.

Mr. Omkar Ashar · Unit No.247/248,Raheja Tesla Industrial District II , Edison Bldg No.-1A,
Plot No.GEN2/1/C/PART, TTC Industrial Area, MIDC, Juinagar, Navi Mumbai 400705, India

☎ +91-22-4967-1438 · ☎ +91-22-4967-1439 · o.ashar@wiska.in · www.wiska.in

Recommended accessories

RDE 40 LT	10063960
BS 28	10064016
ESMU 40	10064193
ORD-S 40	10101762

24.06.2026

Your Contact:

WISKA India Pvt. Ltd.

Mr. Omkar Ashar · Unit No.247/248,Raheja Tesla Industrial District II , Edison Bldg No.-1A,
Plot No.GEN2/1/C/PART, TTC Industrial Area, MIDC, Juinagar, Navi Mumbai 400705, India

☎ +91-22-4967-1438 · ☎ +91-22-4967-1439 · o.ashar@wiska.in · www.wiska.in



Your Contact:

WISKA India Pvt. Ltd.

Mr. Omkar Ashar · Unit No.247/248,Raheja Tesla Industrial District II , Edison Bldg No.-1A,
Plot No.GEN2/1/C/PART, TTC Industrial Area, MIDC, Juinagar, Navi Mumbai 400705, India

☎ +91-22-4967-1438 · ☎ +91-22-4967-1439 · o.ashar@wiska.in · www.wiska.in

Other technical data on request / subject to change without notice