

ESSVG 50 LT RW

Railway pressure compensation cable gland, LowTemp, stainless steel, M50

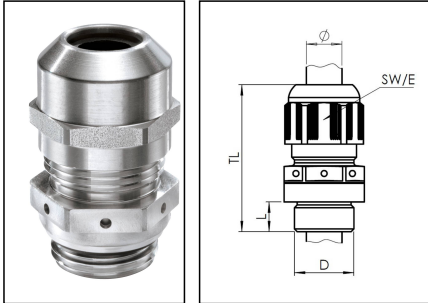

Products may differ in size, colour and appearance to those shown. If you require further information or customisation, please contact us directly.



Material cable gland	Edelstahl A2 (1.4305)
Material sealing gasket	Silicone
Material clamping cage	Polyamide UL94-V0
Material membrane	ePTFE
Airflow at 70mbar	225 l/h
Protection class	IP68
Thread type	M
Ø Connection thread D	50
Lead	1,5
Length screw-in thread L	9 mm
Temp. range min	-60 °C
Temp. range max	100 °C
Ø cable diameter min	21 mm
Ø cable diameter max	35 mm
Key width SW	55 mm
Collar diameter (E)	61 mm
Total length TL	64 mm - 77 mm
Install. torques fitting	30 N m
Install. torques cap nut	30 N m
WISKA-Order no.	10105913
Type	ESSVG 50 LT RW
Packing unit	1
EAN number	4007686013757
Tariff number	73269098
ETIM-Classification	EC000441

Your Contact:

WISKA India Pvt. Ltd.

Mr. Omkar Ashar · Unit No.247/248,Raheja Tesla Industrial District II , Edison Bldg No.-1A,
Plot No.GEN2/1/C/PART, TTC Industrial Area, MIDC, Juinagar, Navi Mumbai 400705, India

☎ +91-22-4967-1438 · ☎ +91-22-4967-1439 · o.ashar@wiska.in · www.wiska.in

Recommended accessories

RDE 50 LT	10063966
BS 35	10064017
ESMU 50	10064194
ORD-S 50	10101763

24.06.2026

Your Contact:

WISKA India Pvt. Ltd.

Mr. Omkar Ashar · Unit No.247/248,Raheja Tesla Industrial District II , Edison Bldg No.-1A,
Plot No.GEN2/1/C/PART, TTC Industrial Area, MIDC, Juinagar, Navi Mumbai 400705, India

☎ +91-22-4967-1438 · ☎ +91-22-4967-1439 · o.ashar@wiska.in · www.wiska.in



Your Contact:

WISKA India Pvt. Ltd.

Mr. Omkar Ashar · Unit No.247/248,Raheja Tesla Industrial District II , Edison Bldg No.-1A,
Plot No.GEN2/1/C/PART, TTC Industrial Area, MIDC, Juinagar, Navi Mumbai 400705, India

☎ +91-22-4967-1438 · ☎ +91-22-4967-1439 · o.ashar@wiska.in · www.wiska.in

Other technical data on request / subject to change without notice