

ESSKV 12 EMV-S RW

EMC Railway cable gland, stainless steel with short thread, M12

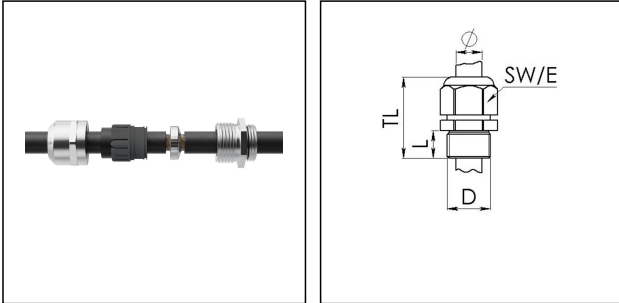

Products may differ in size, colour and appearance to those shown. If you require further information or customisation, please contact us directly.



Material cable gland	Stainless steel A2 (1.4305)
Material sealing gasket	EPDM
Material clamping cage	Polyamide UL94-V0
Material earthing insert	Stainless steel 1.4310
Hazard level EN acc. 45545	R22=HL3 / R23=HL3 / R24=HL3
Protection class	IP69, IP68 (5 bar 30 min)
Thread type	M
Ø Connection thread D	12
Lead	1,5
Length screw-in thread L	5 mm
Temp. range min	-40 °C
Temp. range max	100 °C
Ø cable diameter min	3 mm
Ø cable diameter max	7 mm
Ø cable below cable shield max	5 mm
Key width SW	17 mm
Collar diameter (E)	19 mm
Total length TL	23 mm - 30 mm
Install. torques fitting	4 N m
Install. torques cap nut	4 N m
WISKA-Order no.	10106137
Type	ESSKV 12 EMV-S RW
Packing unit	10
EAN number	4007686017137
Tariff number	73269098

Your Contact:

WISKA India Pvt. Ltd.

Mr. Omkar Ashar · Unit No.247/248,Raheja Tesla Industrial District II , Edison Bldg No.-1A,
Plot No.GEN2/1/C/PART, TTC Industrial Area, MIDC, Juinagar, Navi Mumbai 400705, India

☎ +91-22-4967-1438 · ☎ +91-22-4967-1439 · o.ashar@wiska.in · www.wiska.in

ETIM-Classification

EC000441

Recommended accessories

BS 7

10064005

12.05.2026

Your Contact:

WISKA India Pvt. Ltd.

Mr. Omkar Ashar · Unit No.247/248,Raheja Tesla Industrial District II , Edison Bldg No.-1A,
Plot No.GEN2/1/C/PART, TTC Industrial Area, MIDC, Juinagar, Navi Mumbai 400705, India

☎ +91-22-4967-1438 · ☎ +91-22-4967-1439 · o.ashar@wiska.in · www.wiska.in



Your Contact:

WISKA India Pvt. Ltd.

Mr. Omkar Ashar · Unit No.247/248, Raheja Tesla Industrial District II , Edison Bldg No.-1A,
Plot No.GEN2/1/C/PART, TTC Industrial Area, MIDC, Juinagar, Navi Mumbai 400705, India

☎ +91-22-4967-1438 · ☎ +91-22-4967-1439 · o.ashar@wiska.in · www.wiska.in

Other technical data on request / subject to change without notice