

ESSKV 40 EMV-S RW

EMC Railway cable gland, stainless steel with short thread, M40

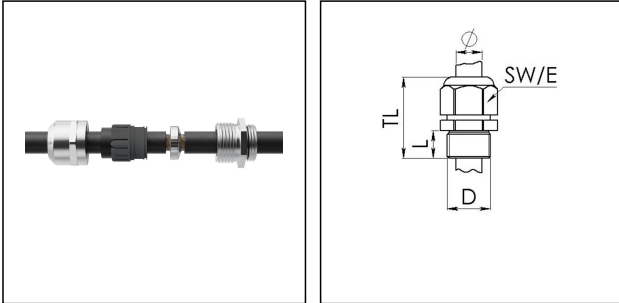

Products may differ in size, colour and appearance to those shown. If you require further information or customisation, please contact us directly.



Material cable gland	Stainless steel A2 (1.4305)
Material sealing gasket	EPDM
Material clamping cage	Polyamide UL94-V0
Material earthing insert	Stainless steel 1.4310
Hazard level EN acc. 45545	R22=HL3 / R23=HL3 / R24=HL3
Protection class	IP69, IP68 (5 bar 30 min)
Thread type	M
Ø Connection thread D	40
Lead	1,5
Length screw-in thread L	8 mm
Temp. range min	-40 °C
Temp. range max	100 °C
Ø cable diameter min	16 mm
Ø cable diameter max	28 mm
Ø cable below cable shield max	26 mm
Key width SW	46 mm
Collar diameter (E)	50 mm
Total length TL	44 mm - 55 mm
Install. torques fitting	20 N m
Install. torques cap nut	20 N m
WISKA-Order no.	10106142
Type	ESSKV 40 EMV-S RW
Packing unit	5
EAN number	4007686017182
Tariff number	73269098

Your Contact:

WISKA India Pvt. Ltd.

Mr. Omkar Ashar · Unit No.247/248,Raheja Tesla Industrial District II , Edison Bldg No.-1A,
Plot No.GEN2/1/C/PART, TTC Industrial Area, MIDC, Juinagar, Navi Mumbai 400705, India

☎ +91-22-4967-1438 · ☎ +91-22-4967-1439 · o.ashar@wiska.in · www.wiska.in

ETIM-Classification

EC000441

Recommended accessories

BS 28

10064016

12.05.2026

Your Contact:

WISKA India Pvt. Ltd.

Mr. Omkar Ashar · Unit No.247/248,Raheja Tesla Industrial District II , Edison Bldg No.-1A,
Plot No.GEN2/1/C/PART, TTC Industrial Area, MIDC, Juinagar, Navi Mumbai 400705, India

☎ +91-22-4967-1438 · ☎ +91-22-4967-1439 · o.ashar@wiska.in · www.wiska.in



Your Contact:

WISKA India Pvt. Ltd.

Mr. Omkar Ashar · Unit No.247/248,Raheja Tesla Industrial District II , Edison Bldg No.-1A,
Plot No.GEN2/1/C/PART, TTC Industrial Area, MIDC, Juinagar, Navi Mumbai 400705, India

☎ +91-22-4967-1438 · ☎ +91-22-4967-1439 · o.ashar@wiska.in · www.wiska.in

Other technical data on request / subject to change without notice