

EMCGV 8-050 LT EMV-Z

EMC Compression gland LowTemp, brass nickel-plated, M8



Products may differ in size, colour and appearance to those shown. If you require further information or customisation, please contact us directly.



Material cable gland	Brass nickel-plated
Material sealing gasket	Silicone
Temp. range min	-60 °C
Temp. range max	180 °C
Protection class	IP68 (5 bar 30 min)
Thread type	M
Ø Connection thread D	8
Lead	1,25
Length screw-in thread L	5 mm
Ø cable diameter min	4 mm
Ø cable diameter max	5,3 mm
Key width SW	11 mm
Collar diameter (E)	12 mm
Total length TL	15 mm - 18,5 mm
Install. torques fitting	2 N m
Install. torques cap nut	2 N m
Order no. nickel-plated	10106542
Type	EMCGV 8-050 LT EMV-Z
Packing unit	50
EAN number	4007686023541
Tariff number	74198090
ETIM-Classification	EC000441

12.05.2026

Your Contact:

WISKA India Pvt. Ltd.

Mr. Omkar Ashar · Unit No.247/248,Raheja Tesla Industrial District II , Edison Bldg No.-1A,
Plot No.GEN2/1/C/PART, TTC Industrial Area, MIDC, Juinagar, Navi Mumbai 400705, India

☎ +91-22-4967-1438 · ☎ +91-22-4967-1439 · o.ashar@wiska.in · www.wiska.in

1

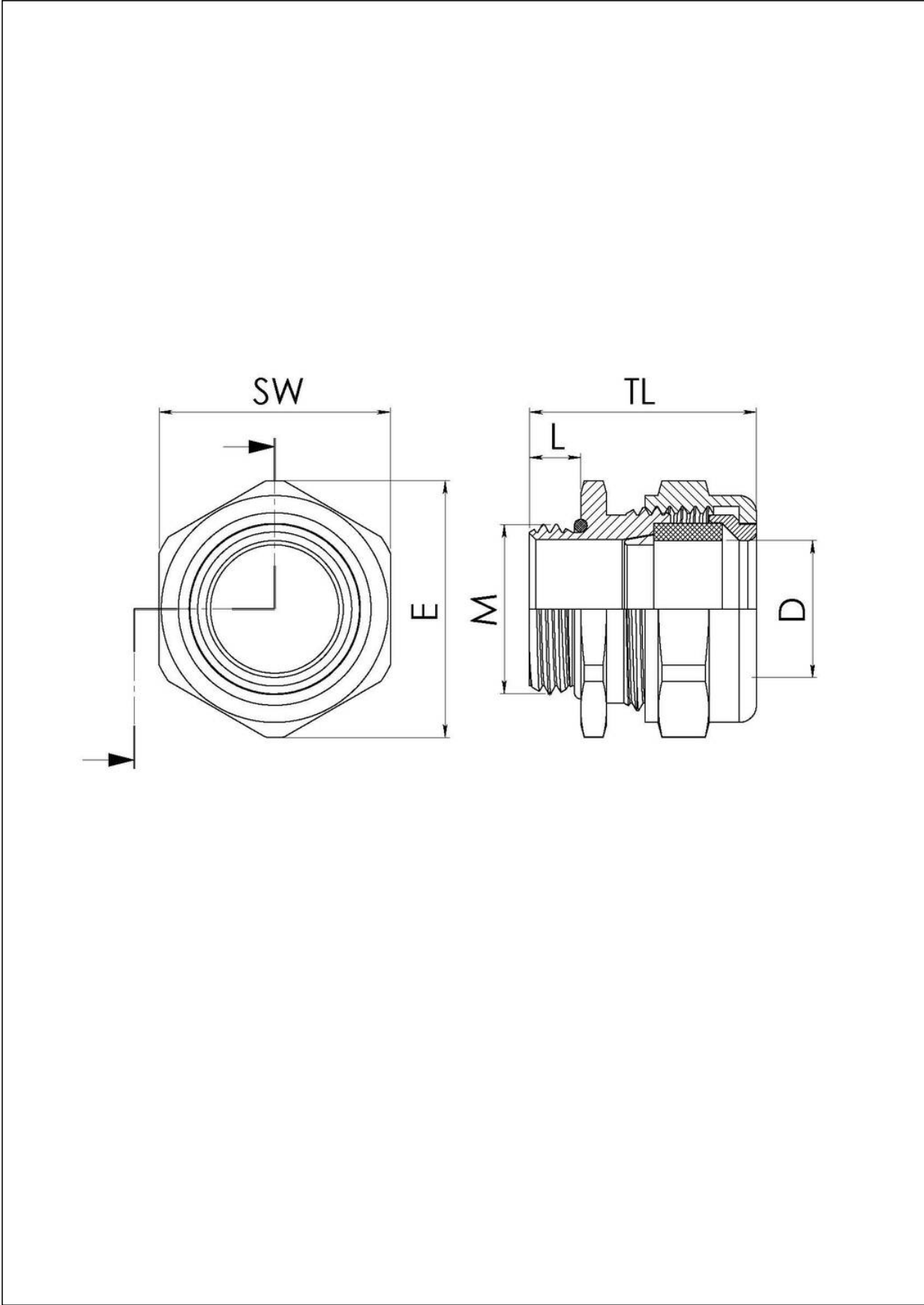

Your Contact:

WISKA India Pvt. Ltd.

Mr. Omkar Ashar · Unit No.247/248,Raheja Tesla Industrial District II , Edison Bldg No.-1A,
Plot No.GEN2/1/C/PART, TTC Industrial Area, MIDC, Juinagar, Navi Mumbai 400705, India

☎ +91-22-4967-1438 · ☎ +91-22-4967-1439 · o.ashar@wiska.in · www.wiska.in