

EMBFS-12-20-BG

Conduit fitting, straight, plastic/brass nickel-plated, RAL 7031, NW 12 / M20

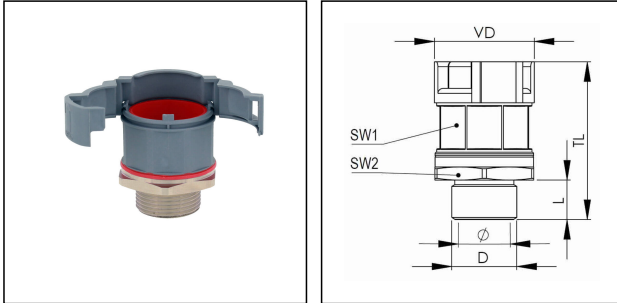

Products may differ in size, colour and appearance to those shown. If you require further information or customisation, please contact us directly.



Material Conduit fitting	polyamide UL94-V0
Material Connection thread	Brass nickel-plated
Material sealing gasket	TPU
Protection class	IP68, IP66
Temp. range min	-40 °C
Temp. range max	100 °C
Operational areas	EN 45545 - Railway
NW	12
Thread type	M
Ø Connection thread D	20
Lead	1,5
Length screw-in thread L	12 mm
Ø closure VD	27,3 mm
Ø inside	11,5 mm
Key width SW1	22 mm
Key width SW2	24 mm
Total length TL	46,5 mm
Type of conduit fitting	straight
UL 1696	Yes
Product Color	RAL 7031
Type	EMBFS-12-20-BG
Order no. RAL 7031	10106881
Packing unit	50
EAN number	4007686033533
Tariff number	74122000

Your Contact:

WISKA India Pvt. Ltd.

Mr. Omkar Ashar · Unit No.247/248,Raheja Tesla Industrial District II , Edison Bldg No.-1A,
Plot No.GEN2/1/C/PART, TTC Industrial Area, MIDC, Juinagar, Navi Mumbai 400705, India

☎ +91-22-4967-1438 · ☎ +91-22-4967-1439 · o.ashar@wiska.in · www.wiska.in

ETIM-Classification

EC001176

Remarks:

UL approval only in conjunction with UL approved corrugated conduits

Recommended accessories

EMMU 20	10063143
BCA-S-12-BG	10107080
BCAV-S-12-BG	10107097
BCIV-S-12-BG	10107113
BCA-12-D-BG	10107128
BCAV-12-D-BG	10107142
BCAB-L-12-BG	10109192
BCAV-H-12-BG	10109209
BCIB-H-12-BG	10109231

12.05.2026

Your Contact:

WISKA India Pvt. Ltd.

Mr. Omkar Ashar · Unit No.247/248,Raheja Tesla Industrial District II , Edison Bldg No.-1A,
Plot No.GEN2/1/C/PART, TTC Industrial Area, MIDC, Juinagar, Navi Mumbai 400705, India

☎ +91-22-4967-1438 · ☎ +91-22-4967-1439 · o.ashar@wiska.in · www.wiska.in



Your Contact:

WISKA India Pvt. Ltd.

Mr. Omkar Ashar · Unit No.247/248,Raheja Tesla Industrial District II , Edison Bldg No.-1A,
Plot No.GEN2/1/C/PART, TTC Industrial Area, MIDC, Juinagar, Navi Mumbai 400705, India

☎ +91-22-4967-1438 · ☎ +91-22-4967-1439 · o.ashar@wiska.in · www.wiska.in

Other technical data on request / subject to change without notice