

EMBFS-29-40-BG

Conduit fitting, straight, plastic/brass nickel-plated, RAL 7031, NW 29 / M40

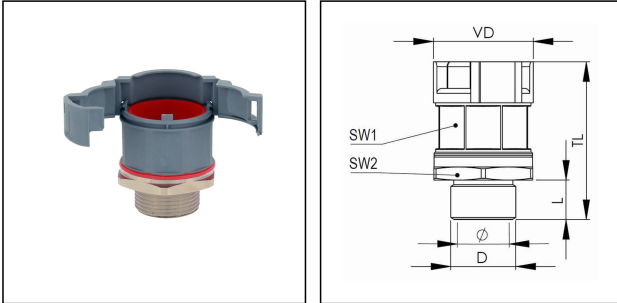

Products may differ in size, colour and appearance to those shown. If you require further information or customisation, please contact us directly.



| | |
|-----------------------------------|---------------------|
| Material Conduit fitting | polyamide UL94-V0 |
| Material Connection thread | Brass nickel-plated |
| Material sealing gasket | TPU |
| Protection class | IP68, IP66 |
| Temp. range min | -40 °C |
| Temp. range max | 100 °C |
| Operational areas | EN 45545 - Railway |
| NW | 29 |
| Thread type | M |
| Ø Connection thread D | 40 |
| Lead | 1,5 |
| Length screw-in thread L | 12 mm |
| Ø closure VD | 46,7 mm |
| Ø inside | 26 mm |
| Key width SW1 | 41 mm |
| Key width SW2 | 46 mm |
| Total length TL | 59,5 mm |
| Type of conduit fitting | straight |
| UL 1696 | Yes |
| Product Color | RAL 7031 |
| Type | EMBFS-29-40-BG |
| Order no. RAL 7031 | 10106888 |
| Packing unit | 10 |
| EAN number | 4007686033670 |
| Tariff number | 74122000 |

Your Contact:

WISKA India Pvt. Ltd.

Mr. Omkar Ashar · Unit No.247/248,Raheja Tesla Industrial District II , Edison Bldg No.-1A,
Plot No.GEN2/1/C/PART, TTC Industrial Area, MIDC, Juinagar, Navi Mumbai 400705, India

☎ +91-22-4967-1438 · ☎ +91-22-4967-1439 · o.ashar@wiska.in · www.wiska.in

ETIM-Classification

EC001176

Remarks:

UL approval only in conjunction with UL approved corrugated conduits

Recommended accessories

| | |
|---------------------|----------|
| EMMU 40 | 10063146 |
| BCA-S-29-BG | 10107084 |
| BCAV-S-29-BG | 10107101 |
| BCIV-S-29-BG | 10107117 |
| BCA-29-D-BG | 10107131 |
| BCAV-29-D-BG | 10107145 |
| BCAB-L-29-BG | 10109196 |
| BCAV-H-29-BG | 10109212 |
| BCIB-H-29-BG | 10109235 |

12.05.2026

Your Contact:

WISKA India Pvt. Ltd.

Mr. Omkar Ashar · Unit No.247/248,Raheja Tesla Industrial District II , Edison Bldg No.-1A,
Plot No.GEN2/1/C/PART, TTC Industrial Area, MIDC, Juinagar, Navi Mumbai 400705, India

☎ +91-22-4967-1438 · ☎ +91-22-4967-1439 · o.ashar@wiska.in · www.wiska.in



Your Contact:

WISKA India Pvt. Ltd.

Mr. Omkar Ashar · Unit No.247/248,Raheja Tesla Industrial District II , Edison Bldg No.-1A,
Plot No.GEN2/1/C/PART, TTC Industrial Area, MIDC, Juinagar, Navi Mumbai 400705, India

☎ +91-22-4967-1438 · ☎ +91-22-4967-1439 · o.ashar@wiska.in · www.wiska.in

Other technical data on request / subject to change without notice