

EMBFS-36-40-BK

Conduit fitting, straight, plastic/brass nickel-plated, RAL 9005, NW 36 / M40

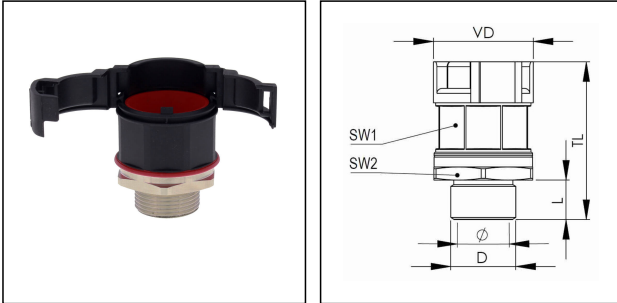

Products may differ in size, colour and appearance to those shown. If you require further information or customisation, please contact us directly.



Material Conduit fitting	polyamide UL94-V0
Material Connection thread	Brass nickel-plated
Material sealing gasket	TPU
Protection class	IP68, IP66
Temp. range min	-40 °C
Temp. range max	100 °C
Operational areas	EN 45545 - Railway
NW	36
Thread type	M
Ø Connection thread D	40
Lead	1,5
Length screw-in thread L	12 mm
Ø closure VD	55,7 mm
Ø inside	33,5 mm
Key width SW1	50 mm
Key width SW2	55 mm
Total length TL	60,3 mm
Type of conduit fitting	straight
UL 1696	Yes
Product Color	RAL 9005
Type	EMBFS-36-40-BK
Order no. RAL 9005	10106905
Packing unit	10
EAN number	4007686033991
Tariff number	74122000

Your Contact:

WISKA India Pvt. Ltd.

Mr. Omkar Ashar · Unit No.247/248,Raheja Tesla Industrial District II , Edison Bldg No.-1A,
Plot No.GEN2/1/C/PART, TTC Industrial Area, MIDC, Juinagar, Navi Mumbai 400705, India

☎ +91-22-4967-1438 · ☎ +91-22-4967-1439 · o.ashar@wiska.in · www.wiska.in

ETIM-Classification

EC001176

Remarks:

UL approval only in conjunction with UL approved corrugated conduits

Recommended accessories

EMMU 40	10063146
BCA-S-36-BK	10107078
BCAV-S-36-BK	10107093
BCIV-S-36-BK	10107110
BCA-36-D-BK	10107125
BCAV-36-D-BK	10107139
BCAB-L-36-BK	10109188
BCAV-H-36-BK	10109205
BCIB-H-36-BK	10109227

12.05.2026

Your Contact:

WISKA India Pvt. Ltd.

Mr. Omkar Ashar · Unit No.247/248,Raheja Tesla Industrial District II , Edison Bldg No.-1A,
Plot No.GEN2/1/C/PART, TTC Industrial Area, MIDC, Juinagar, Navi Mumbai 400705, India

☎ +91-22-4967-1438 · ☎ +91-22-4967-1439 · o.ashar@wiska.in · www.wiska.in



Your Contact:

WISKA India Pvt. Ltd.

Mr. Omkar Ashar · Unit No.247/248,Raheja Tesla Industrial District II , Edison Bldg No.-1A,
Plot No.GEN2/1/C/PART, TTC Industrial Area, MIDC, Juinagar, Navi Mumbai 400705, India

☎ +91-22-4967-1438 · ☎ +91-22-4967-1439 · o.ashar@wiska.in · www.wiska.in

Other technical data on request / subject to change without notice