

EBF90-36-40-BG

Conduit fitting, 90° angle, plastic

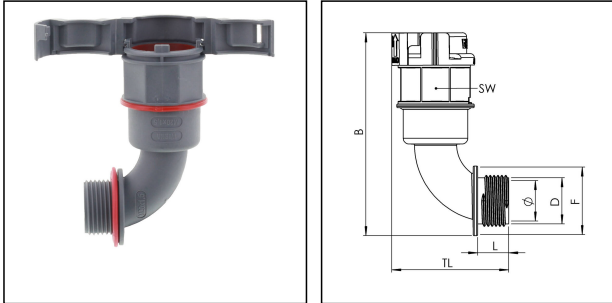

Products may differ in size, colour and appearance to those shown. If you require further information or customisation, please contact us directly.



Material Conduit fitting	polyamide UL94-V0
Material Connection thread	polyamide UL94-V0
Material sealing gasket	TPU
Protection class	IP66, IP68
Temp. range min	-40 °C
Temp. range max	100 °C
Operational areas	EN 45545 - Railway
NW	36
Thread type	M
Ø Connection thread D	40
Lead	1,5
Length screw-in thread L	14,5 mm
Ø inside	33,5 mm
Ø Gasket F	50 mm
Key width SW	50 mm
Width B	119,4 mm
Total length TL	74,8 mm
Type of conduit fitting	90° Angle
UL 1696	Yes
Product Color	RAL 7031
Type	EBF90-36-40-BG
Order no. RAL 7031	10106972
Packing unit	10
EAN number	4007686035339
Tariff number	39174000

Your Contact:

WISKA India Pvt. Ltd.

Mr. Omkar Ashar · Unit No.247/248,Raheja Tesla Industrial District II , Edison Bldg No.-1A,
Plot No.GEN2/1/C/PART, TTC Industrial Area, MIDC, Juinagar, Navi Mumbai 400705, India

☎ +91-22-4967-1438 · ☎ +91-22-4967-1439 · o.ashar@wiska.in · www.wiska.in

ETIM-Classification

EC001176

Remarks:

UL approval only in conjunction with UL approved corrugated conduits

Recommended accessories

BCA-S-36-BG	10107085
BCAV-S-36-BG	10107102
BCIV-S-36-BG	10107118
BCA-36-D-BG	10107132
BCAV-36-D-BG	10107146
BCAB-L-36-BG	10109197
BCAV-H-36-BG	10109213
BCIB-H-36-BG	10109236

12.05.2026

Your Contact:

WISKA India Pvt. Ltd.

Mr. Omkar Ashar · Unit No.247/248,Raheja Tesla Industrial District II , Edison Bldg No.-1A,
Plot No.GEN2/1/C/PART, TTC Industrial Area, MIDC, Juinagar, Navi Mumbai 400705, India

☎ +91-22-4967-1438 · ☎ +91-22-4967-1439 · o.ashar@wiska.in · www.wiska.in



Your Contact:

WISKA India Pvt. Ltd.

Mr. Omkar Ashar · Unit No.247/248,Raheja Tesla Industrial District II , Edison Bldg No.-1A,
Plot No.GEN2/1/C/PART, TTC Industrial Area, MIDC, Juinagar, Navi Mumbai 400705, India

☎ +91-22-4967-1438 · ☎ +91-22-4967-1439 · o.ashar@wiska.in · www.wiska.in