

EMBF90-23-32-BG

Conduit fitting, 90° angle, brass

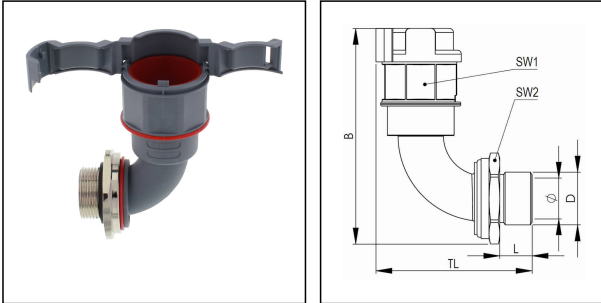

Products may differ in size, colour and appearance to those shown. If you require further information or customisation, please contact us directly.



Material Conduit fitting	polyamide UL94-V0
Material Connection thread	Brass nickel-plated
Material sealing gasket	TPU
Protection class	IP68, IP66
Temp. range min	-40 °C
Temp. range max	100 °C
Operational areas	EN 45545 - Railway
NW	23
Thread type	M
Ø Connection thread D	32
Lead	1,5
Length screw-in thread L	12 mm
Ø inside	18 mm
Key width SW1	41 mm
Key width SW2	36 mm
Width B	96,2 mm
Total length TL	59,9 mm
Type of conduit fitting	90° Angle
UL 1696	Yes
Product Color	RAL 7031
Type	EMBF90-23-32-BG
Order no. RAL 7031	10107006
Packing unit	25
EAN number	4007686036046
Tariff number	74122000

Your Contact:

WISKA India Pvt. Ltd.

Mr. Omkar Ashar · Unit No.247/248,Raheja Tesla Industrial District II , Edison Bldg No.-1A,
Plot No.GEN2/1/C/PART, TTC Industrial Area, MIDC, Juinagar, Navi Mumbai 400705, India

☎ +91-22-4967-1438 · ☎ +91-22-4967-1439 · o.ashar@wiska.in · www.wiska.in

ETIM-Classification

EC001176

Remarks:

UL approval only in conjunction with UL approved corrugated conduits

Recommended accessories

EMMU 32	10063145
BCA-S-23-BG	10107083
BCAV-S-23-BG	10107100
BCIV-S-23-BG	10107116
BCA-23-D-BG	10107130
BCAV-23-D-BG	10107144
BCAB-L-23-BG	10109195
BCAV-H-23-BG	10109211
BCIB-H-23-BG	10109234

12.05.2026

Your Contact:

WISKA India Pvt. Ltd.

Mr. Omkar Ashar · Unit No.247/248,Raheja Tesla Industrial District II , Edison Bldg No.-1A,
Plot No.GEN2/1/C/PART, TTC Industrial Area, MIDC, Juinagar, Navi Mumbai 400705, India

☎ +91-22-4967-1438 · ☎ +91-22-4967-1439 · o.ashar@wiska.in · www.wiska.in



Your Contact:

WISKA India Pvt. Ltd.

Mr. Omkar Ashar · Unit No.247/248, Raheja Tesla Industrial District II , Edison Bldg No.-1A,
Plot No.GEN2/1/C/PART, TTC Industrial Area, MIDC, Juinagar, Navi Mumbai 400705, India

☎ +91-22-4967-1438 · ☎ +91-22-4967-1439 · o.ashar@wiska.in · www.wiska.in