

EMBF90-29-40-BG

Conduit fitting, 90° angle, brass

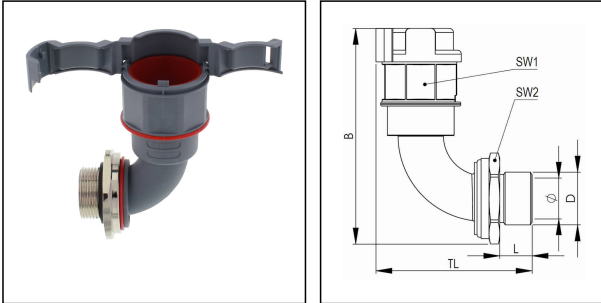

Products may differ in size, colour and appearance to those shown. If you require further information or customisation, please contact us directly.



Material Conduit fitting	polyamide UL94-V0
Material Connection thread	Brass nickel-plated
Material sealing gasket	TPU
Protection class	IP66, IP68
Temp. range min	-40 °C
Temp. range max	100 °C
Operational areas	EN 45545 - Railway
NW	29
Thread type	M
Ø Connection thread D	40
Lead	1,5
Length screw-in thread L	12 mm
Ø inside	26 mm
Key width SW1	46 mm
Key width SW2	41 mm
Width B	108,7 mm
Total length TL	65,9 mm
Type of conduit fitting	90° Angle
UL 1696	Yes
Product Color	RAL 7031
Type	EMBF90-29-40-BG
Order no. RAL 7031	10107008
Packing unit	10
EAN number	4007686036084
Tariff number	74122000

Your Contact:

WISKA India Pvt. Ltd.

Mr. Omkar Ashar · Unit No.247/248,Raheja Tesla Industrial District II , Edison Bldg No.-1A,
Plot No.GEN2/1/C/PART, TTC Industrial Area, MIDC, Juinagar, Navi Mumbai 400705, India

+91-22-4967-1438 · +91-22-4967-1439 · o.ashar@wiska.in · www.wiska.in

ETIM-Classification

EC001176

Remarks:

UL approval only in conjunction with UL approved corrugated conduits

Recommended accessories

EMMU 40	10063146
BCA-S-29-BG	10107084
BCAV-S-29-BG	10107101
BCIV-S-29-BG	10107117
BCA-29-D-BG	10107131
BCAV-29-D-BG	10107145
BCAB-L-29-BG	10109196
BCAV-H-29-BG	10109212
BCIB-H-29-BG	10109235

12.05.2026

Your Contact:

WISKA India Pvt. Ltd.

Mr. Omkar Ashar · Unit No.247/248,Raheja Tesla Industrial District II , Edison Bldg No.-1A,
Plot No.GEN2/1/C/PART, TTC Industrial Area, MIDC, Juinagar, Navi Mumbai 400705, India

☎ +91-22-4967-1438 · ☎ +91-22-4967-1439 · o.ashar@wiska.in · www.wiska.in



Your Contact:

WISKA India Pvt. Ltd.

Mr. Omkar Ashar · Unit No.247/248, Raheja Tesla Industrial District II, Edison Bldg No.-1A,
Plot No.GEN2/1/C/PART, TTC Industrial Area, MIDC, Juinagar, Navi Mumbai 400705, India

☎ +91-22-4967-1438 · ☎ +91-22-4967-1439 · o.ashar@wiska.in · www.wiska.in