

## EMBF90-36-40-BK

Conduit fitting, 90° angle, brass

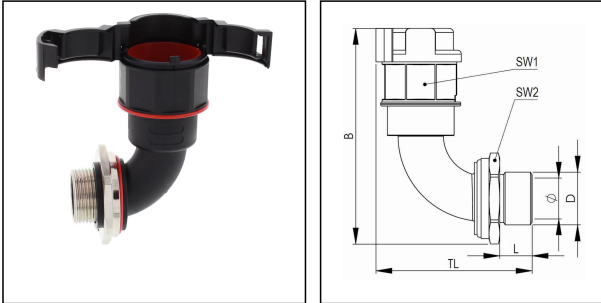

Products may differ in size, colour and appearance to those shown. If you require further information or customisation, please contact us directly.



<b>Material Conduit fitting</b>	polyamide UL94-V0
<b>Material Connection thread</b>	Brass nickel-plated
<b>Material sealing gasket</b>	TPU
<b>Protection class</b>	IP68, IP66
<b>Temp. range min</b>	-40 °C
<b>Temp. range max</b>	100 °C
<b>Operational areas</b>	EN 45545 - Railway
<b>NW</b>	36
<b>Thread type</b>	M
<b>Ø Connection thread D</b>	40
<b>Lead</b>	1,5
<b>Length screw-in thread L</b>	12 mm
<b>Ø inside</b>	33 mm
<b>Key width SW1</b>	50 mm
<b>Key width SW2</b>	50 mm
<b>Width B</b>	122,2 mm
<b>Total length TL</b>	80,7 mm
<b>Type of conduit fitting</b>	90° Angle
<b>UL 1696</b>	Yes
<b>Product Color</b>	RAL 9005
<b>Type</b>	EMBF90-36-40-BK
<b>Order no. RAL 9005</b>	10107024
<b>Packing unit</b>	10
<b>EAN number</b>	4007686036404
<b>Tariff number</b>	74122000

Your Contact:

WISKA India Pvt. Ltd.

Mr. Omkar Ashar · Unit No.247/248,Raheja Tesla Industrial District II , Edison Bldg No.-1A,  
Plot No.GEN2/1/C/PART, TTC Industrial Area, MIDC, Juinagar, Navi Mumbai 400705, India

☎ +91-22-4967-1438 · ☎ +91-22-4967-1439 · o.ashar@wiska.in · www.wiska.in

**ETIM-Classification**

EC001176

Remarks:

UL approval only in conjunction with UL approved corrugated conduits

#### Recommended accessories

<b>EMMU 40</b>	10063146
<b>BCA-S-36-BK</b>	10107078
<b>BCAV-S-36-BK</b>	10107093
<b>BCIV-S-36-BK</b>	10107110
<b>BCA-36-D-BK</b>	10107125
<b>BCAV-36-D-BK</b>	10107139
<b>BCAB-L-36-BK</b>	10109188
<b>BCAV-H-36-BK</b>	10109205
<b>BCIB-H-36-BK</b>	10109227

12.05.2026

Your Contact:

**WISKA India Pvt. Ltd.**

Mr. Omkar Ashar · Unit No.247/248,Raheja Tesla Industrial District II , Edison Bldg No.-1A,  
Plot No.GEN2/1/C/PART, TTC Industrial Area, MIDC, Juinagar, Navi Mumbai 400705, India

☎ +91-22-4967-1438 · ☎ +91-22-4967-1439 · o.ashar@wiska.in · www.wiska.in



Your Contact:

**WISKA India Pvt. Ltd.**

Mr. Omkar Ashar · Unit No.247/248, Raheja Tesla Industrial District II, Edison Bldg No.-1A,  
Plot No.GEN2/1/C/PART, TTC Industrial Area, MIDC, Juinagar, Navi Mumbai 400705, India

☎ +91-22-4967-1438 · ☎ +91-22-4967-1439 · o.ashar@wiska.in · www.wiska.in