

EMBF45-36-50-BK

Conduit fitting, 45° angle, plastic/brass, RAL 9005, NW 36 / M50

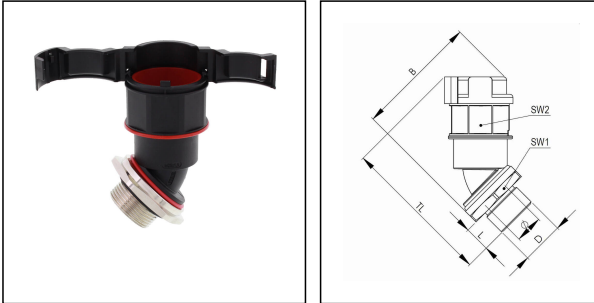

Products may differ in size, colour and appearance to those shown. If you require further information or customisation, please contact us directly.



Material Conduit fitting	polyamide UL94-V0
Material Connection thread	Brass nickel-plated
Material sealing gasket	TPU
Protection class	IP68, IP66
Temp. range min	-40 °C
Temp. range max	100 °C
Operational areas	EN 45545 - Railway
NW	36
Thread type	M
Ø Connection thread D	50
Lead	1,5
Length screw-in thread L	14 mm
Ø inside	33,5 mm
Key width SW1	50 mm
Key width SW2	50 mm
Width B	96,6 mm
Total length TL	98,5 mm
Type of conduit fitting	45° Angle
UL 1696	Yes
Product Color	RAL 9005
Type	EMBF45-36-50-BK
Order no. RAL 9005	10107330
Packing unit	10
EAN number	4007686041903
Tariff number	74122000

Your Contact:

WISKA India Pvt. Ltd.

Mr. Omkar Ashar · Unit No.247/248,Raheja Tesla Industrial District II , Edison Bldg No.-1A,
Plot No.GEN2/1/C/PART, TTC Industrial Area, MIDC, Juinagar, Navi Mumbai 400705, India

☎ +91-22-4967-1438 · ☎ +91-22-4967-1439 · o.ashar@wiska.in · www.wiska.in

ETIM-Classification

EC001176

Remarks:

UL approval only in conjunction with UL approved corrugated conduits

Recommended accessories

EMMU 50	10063147
BCA-S-36-BK	10107078
BCAV-S-36-BK	10107093
BCIV-S-36-BK	10107110
BCA-36-D-BK	10107125
BCAV-36-D-BK	10107139
BCAB-L-36-BK	10109188
BCAV-H-36-BK	10109205
BCIB-H-36-BK	10109227

12.05.2026

Your Contact:

WISKA India Pvt. Ltd.

Mr. Omkar Ashar · Unit No.247/248,Raheja Tesla Industrial District II , Edison Bldg No.-1A,
Plot No.GEN2/1/C/PART, TTC Industrial Area, MIDC, Juinagar, Navi Mumbai 400705, India

☎ +91-22-4967-1438 · ☎ +91-22-4967-1439 · o.ashar@wiska.in · www.wiska.in

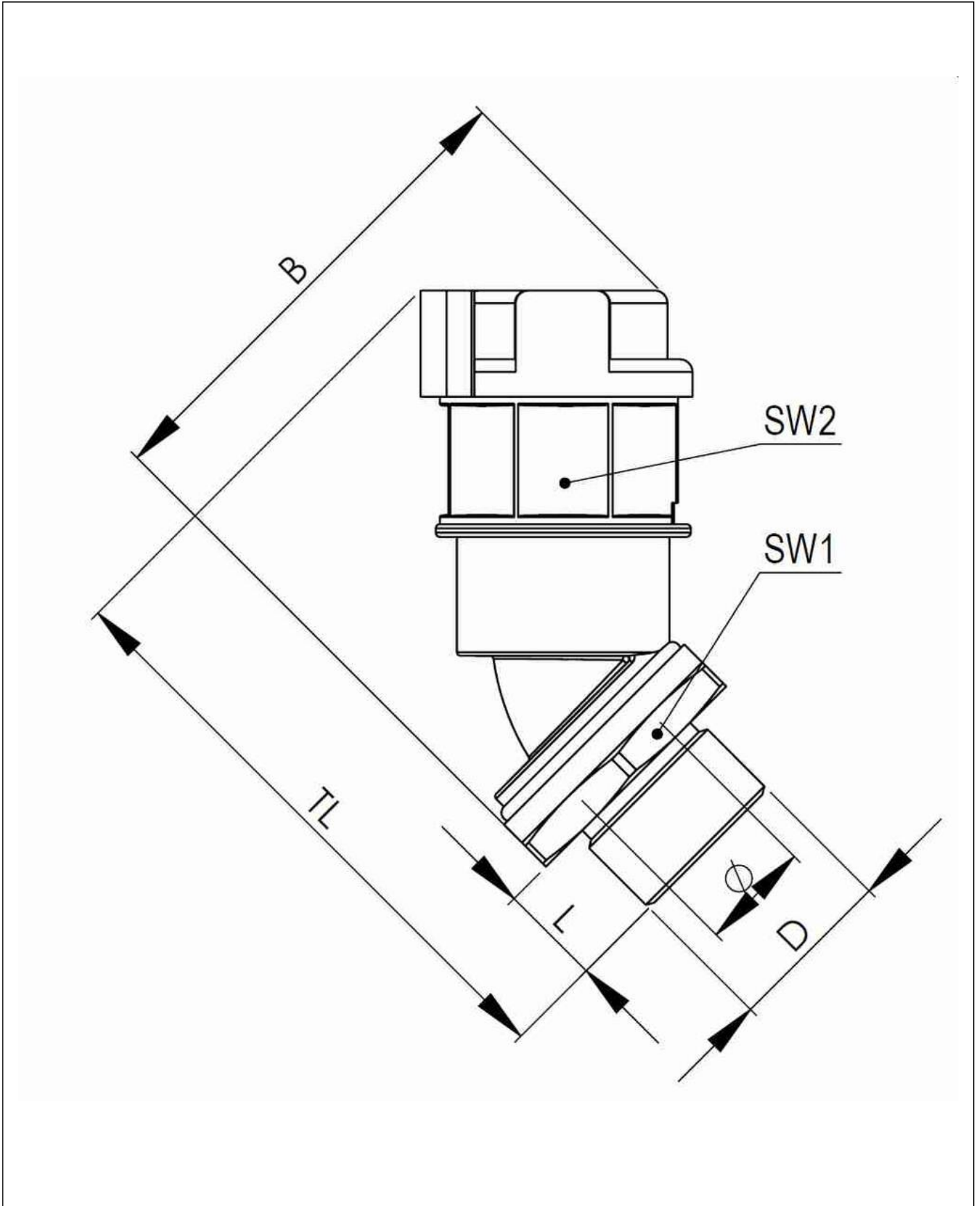

Your Contact:

WISKA India Pvt. Ltd.

Mr. Omkar Ashar · Unit No.247/248,Raheja Tesla Industrial District II , Edison Bldg No.-1A,
Plot No.GEN2/1/C/PART, TTC Industrial Area, MIDC, Juinagar, Navi Mumbai 400705, India

☎ +91-22-4967-1438 · ☎ +91-22-4967-1439 · o.ashar@wiska.in · www.wiska.in