

EMBF90I-10-16-BK

Conduit fitting, internal thread, 90° angle, brass

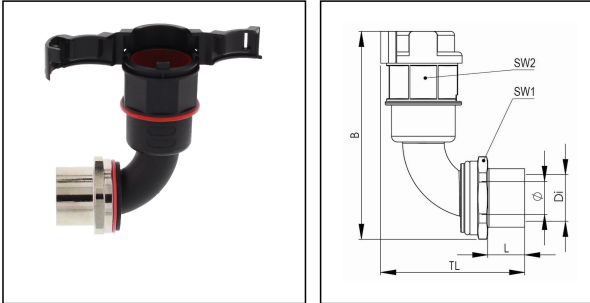

Products may differ in size, colour and appearance to those shown. If you require further information or customisation, please contact us directly.



Material Conduit fitting	polyamide UL94-V0
Material Connection thread	Brass nickel-plated
Material sealing gasket	TPU
Protection class	IP66, IP68
Temp. range min	-40 °C
Temp. range max	100 °C
Operational areas	EN 45545 - Railway
NW	10
Thread type	M
Ø Connection thread D	16
Lead	1,5
Length screw-in thread L	13 mm
Ø inside	7 mm
Key width SW1	22 mm
Key width SW2	20 mm
Width B	67,7 mm
Total length TL	45,9 mm
Type of conduit fitting	90° Angle
UL 1696	Yes
Product Color	RAL 9005
Type	EMBF90I-10-16-BK
Order no. RAL 9005	10107363
Packing unit	50
EAN number	4007686042429
Tariff number	74122000

Your Contact:

WISKA India Pvt. Ltd.

Mr. Omkar Ashar · Unit No.247/248,Raheja Tesla Industrial District II , Edison Bldg No.-1A,
Plot No.GEN2/1/C/PART, TTC Industrial Area, MIDC, Juinagar, Navi Mumbai 400705, India

☎ +91-22-4967-1438 · ☎ +91-22-4967-1439 · o.ashar@wiska.in · www.wiska.in

ETIM-Classification

EC001176

Remarks:

UL approval only in conjunction with UL approved corrugated conduits

Recommended accessories

BCA-S-10-BK	10107072
BCAV-S-10-BK	10107087
BCIV-S-10-BK	10107104
BCA-10-D-BK	10107120
BCAV-10-D-BK	10107134
BCAB-L-10-BK	10109182
BCAV-H-10-BK	10109200
BCIB-H-10-BK	10109221

12.05.2026

Your Contact:

WISKA India Pvt. Ltd.

Mr. Omkar Ashar · Unit No.247/248,Raheja Tesla Industrial District II , Edison Bldg No.-1A,
Plot No.GEN2/1/C/PART, TTC Industrial Area, MIDC, Juinagar, Navi Mumbai 400705, India

☎ +91-22-4967-1438 · ☎ +91-22-4967-1439 · o.ashar@wiska.in · www.wiska.in



Your Contact:

WISKA India Pvt. Ltd.

Mr. Omkar Ashar · Unit No.247/248,Raheja Tesla Industrial District II , Edison Bldg No.-1A,
Plot No.GEN2/1/C/PART, TTC Industrial Area, MIDC, Juinagar, Navi Mumbai 400705, India

☎ +91-22-4967-1438 · ☎ +91-22-4967-1439 · o.ashar@wiska.in · www.wiska.in