

## EBFSI-23-32-BG

Adaptor-Internal Thread, polyamide, RAL 7031, NW 23-M32

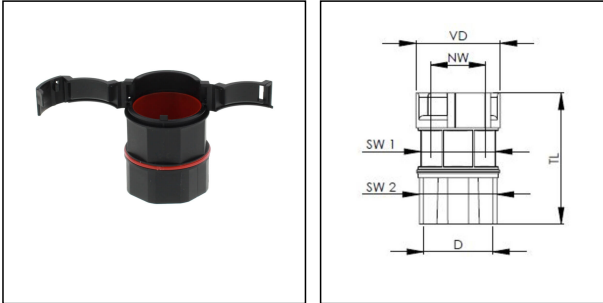

Products may differ in size, colour and appearance to those shown. If you require further information or customisation, please contact us directly.



<b>Material Conduit fitting</b>	polyamide UL94-V0
<b>Material Connection thread</b>	polyamide UL94-V0
<b>Material sealing gasket</b>	TPU
<b>Protection class</b>	IP68
<b>Temp. range min</b>	-40 °C
<b>Temp. range max</b>	100 °C
<b>NW</b>	23
<b>Thread type</b>	M
<b>Ø Connection thread D</b>	32
<b>Lead</b>	1,5
<b>Length screw-in thread L</b>	14,5 mm
<b>Ø closure VD</b>	42,3 mm
<b>Key width SW1</b>	36 mm
<b>Key width SW2</b>	36 mm
<b>Total length TL</b>	56,3 mm
<b>Product Color</b>	RAL 7031
<b>Type</b>	EBFSI-23-32-BG
<b>Order no. RAL 7031</b>	10109750
<b>Packing unit</b>	25
<b>EAN number</b>	4007686264920
<b>Tariff number</b>	39269097
<b>ETIM-Classification</b>	EC001176

27.06.2026

Your Contact:

WISKA India Pvt. Ltd.

Mr. Omkar Ashar · Unit No.247/248,Raheja Tesla Industrial District II , Edison Bldg No.-1A,  
Plot No.GEN2/1/C/PART, TTC Industrial Area, MIDC, Juinagar, Navi Mumbai 400705, India

☎ +91-22-4967-1438 · ☎ +91-22-4967-1439 · o.ashar@wiska.in · www.wiska.in

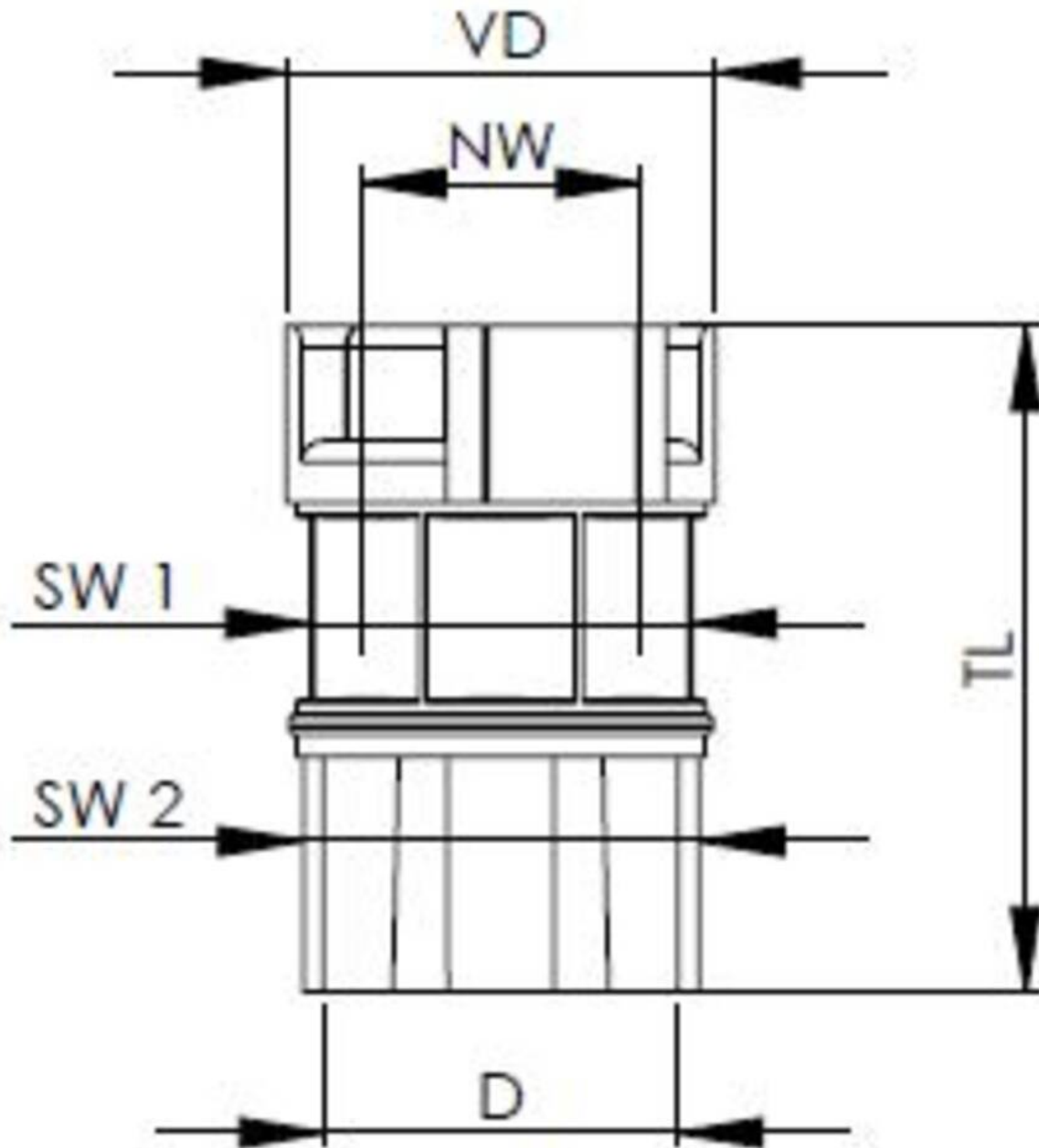

Your Contact:

**WISKA India Pvt. Ltd.**

Mr. Omkar Ashar · Unit No.247/248,Raheja Tesla Industrial District II , Edison Bldg No.-1A,  
Plot No.GEN2/1/C/PART, TTC Industrial Area, MIDC, Juinagar, Navi Mumbai 400705, India

☎ +91-22-4967-1438 · ☎ +91-22-4967-1439 · o.ashar@wiska.in · www.wiska.in