

## EVSGS-ORD 32 LG

Stop end hexagonal with mounted O-ring, polyamide, RAL 7035, M32

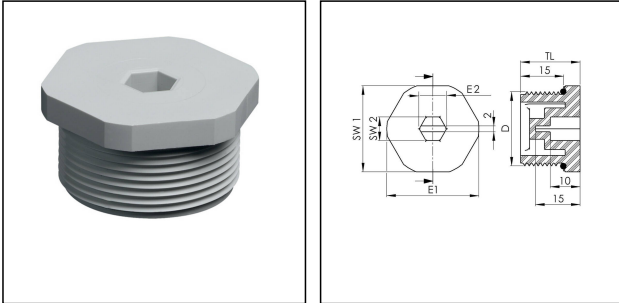

Products may differ in size, colour and appearance to those shown. If you require further information or customisation, please contact us directly.



<b>Material</b>	Polyamide
<b>Material sealing gasket</b>	EPDM
<b>Temp. range min</b>	-40 °C
<b>Temp. range max</b>	100 °C
<b>Protection class</b>	IP66 / IP68
<b>Thread type</b>	M
<b>Ø Connection thread D</b>	32
<b>Lead</b>	1,5
<b>Length screw-in thread L</b>	15 mm
<b>Key width SW1</b>	36 mm
<b>Key width SW2</b>	8 mm
<b>Collar diameter E1</b>	39 mm
<b>Collar diameter E2</b>	9 mm
<b>Total length TL</b>	20 mm
<b>Product Color</b>	RAL 7035
<b>Order no. RAL 7035</b>	10110111
<b>Type</b>	EVSGS-ORD 32 LG
<b>Packing unit</b>	100
<b>EAN number</b>	4007686133707
<b>Tariff number</b>	39269097

### Recommended accessories

<b>EMUG 32 LG</b>	10060774
-------------------	----------

Your Contact:

WISKA India Pvt. Ltd.

Mr. Omkar Ashar · Unit No.247/248,Raheja Tesla Industrial District II , Edison Bldg No.-1A,  
Plot No.GEN2/1/C/PART, TTC Industrial Area, MIDC, Juinagar, Navi Mumbai 400705, India

☎ +91-22-4967-1438 · ☎ +91-22-4967-1439 · o.ashar@wiska.in · www.wiska.in

23.05.2026

Your Contact:

**WISKA India Pvt. Ltd.**

Mr. Omkar Ashar · Unit No.247/248,Raheja Tesla Industrial District II , Edison Bldg No.-1A,  
Plot No.GEN2/1/C/PART, TTC Industrial Area, MIDC, Juinagar, Navi Mumbai 400705, India

☎ +91-22-4967-1438 · ☎ +91-22-4967-1439 · o.ashar@wiska.in · www.wiska.in

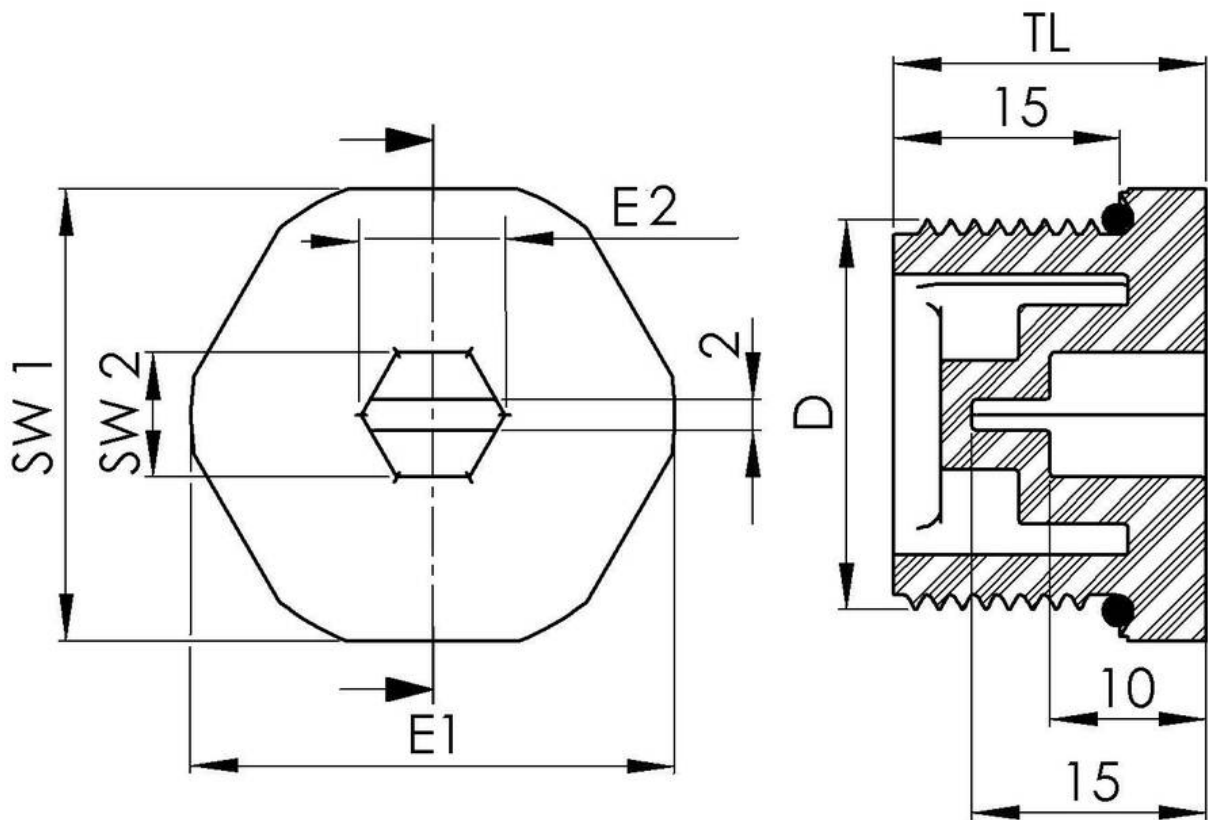

Your Contact:

**WISKA India Pvt. Ltd.**

Mr. Omkar Ashar · Unit No.247/248, Raheja Tesla Industrial District II, Edison Bldg No.-1A,  
Plot No.GEN2/1/C/PART, TTC Industrial Area, MIDC, Juinagar, Navi Mumbai 400705, India

☎ +91-22-4967-1438 · ☎ +91-22-4967-1439 · o.ashar@wiska.in · www.wiska.in

Other technical data on request / subject to change without notice