

EWI90 32 BK

Elbow 90° polyamide, RAL 9005, M32

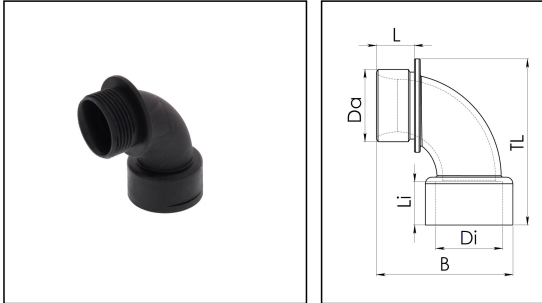

Products may differ in size, colour and appearance to those shown. If you require further information or customisation, please contact us directly.



Material	Polyamide UL94-V0
Temp. range min	-40 °C
Temp. range max	100 °C
Hazard level EN acc. 45545	R22=HL3 / R23=HL3 / R24=HL3
Thread type	M
Ø Connection thread D	32
Lead	1,5
Length screw-in thread L	13 mm
Total length TL	65 mm
Width B	55 mm
Length internal thread	14,9 mm
Type of conduit fitting	90° Angle
Product Color	RAL 9005
Order no. RAL 9005	10110786
Type	EWI90 32 BK
Packing unit	5
EAN number	4007686257564
Tariff number	39269097
ETIM-Classification	EC000441

Recommended accessories

EMUG 32 BK	10061784
EADR 32	10062805

Your Contact:

WISKA India Pvt. Ltd.

Mr. Omkar Ashar · Unit No.247/248,Raheja Tesla Industrial District II , Edison Bldg No.-1A,
Plot No.GEN2/1/C/PART, TTC Industrial Area, MIDC, Juinagar, Navi Mumbai 400705, India

☎ +91-22-4967-1438 · ☎ +91-22-4967-1439 · o.ashar@wiska.in · www.wiska.in

23.05.2026

Your Contact:

WISKA India Pvt. Ltd.

Mr. Omkar Ashar · Unit No.247/248,Raheja Tesla Industrial District II , Edison Bldg No.-1A,
Plot No.GEN2/1/C/PART, TTC Industrial Area, MIDC, Juinagar, Navi Mumbai 400705, India

☎ +91-22-4967-1438 · ☎ +91-22-4967-1439 · o.ashar@wiska.in · www.wiska.in

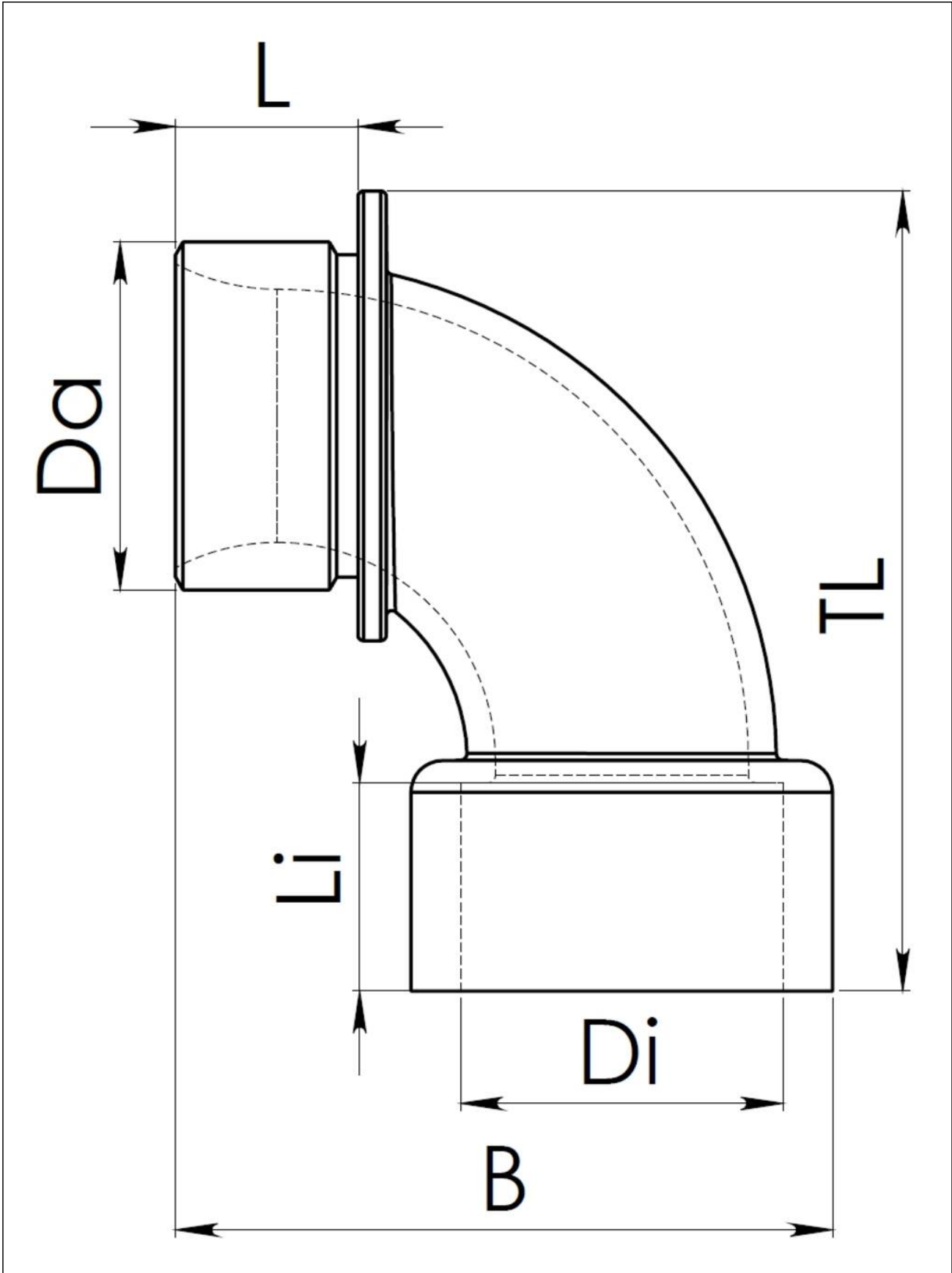

Your Contact:

WISKA India Pvt. Ltd.

Mr. Omkar Ashar · Unit No.247/248,Raheja Tesla Industrial District II , Edison Bldg No.-1A,
Plot No.GEN2/1/C/PART, TTC Industrial Area, MIDC, Juinagar, Navi Mumbai 400705, India

☎ +91-22-4967-1438 · ☎ +91-22-4967-1439 · o.ashar@wiska.in · www.wiska.in

Other technical data on request / subject to change without notice