

## EWI90 40 BK

Elbow 90° polyamide, RAL 9005, M40

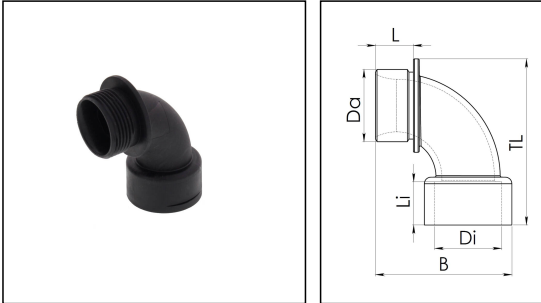

Products may differ in size, colour and appearance to those shown. If you require further information or customisation, please contact us directly.



<b>Material</b>	Polyamide UL94-V0
<b>Temp. range min</b>	-40 °C
<b>Temp. range max</b>	100 °C
<b>Hazard level EN acc. 45545</b>	R22=HL3 / R23=HL3 / R24=HL3
<b>Thread type</b>	M
<b>Ø Connection thread D</b>	40
<b>Lead</b>	1,5
<b>Length screw-in thread L</b>	15 mm
<b>Total length TL</b>	81 mm
<b>Width B</b>	70 mm
<b>Length internal thread</b>	15,3 mm
<b>Type of conduit fitting</b>	90° Angle
<b>Product Color</b>	RAL 9005
<b>Order no. RAL 9005</b>	10110787
<b>Type</b>	EWI90 40 BK
<b>Packing unit</b>	5
<b>EAN number</b>	4007686257588
<b>Tariff number</b>	39269097
<b>ETIM-Classification</b>	EC000441

### Recommended accessories

<b>EMUG 40 BK</b>	10061785
<b>EADR 40</b>	10062806

Your Contact:

WISKA India Pvt. Ltd.

Mr. Omkar Ashar · Unit No.247/248,Raheja Tesla Industrial District II , Edison Bldg No.-1A,  
Plot No.GEN2/1/C/PART, TTC Industrial Area, MIDC, Juinagar, Navi Mumbai 400705, India

☎ +91-22-4967-1438 · ☎ +91-22-4967-1439 · o.ashar@wiska.in · www.wiska.in

23.05.2026

Your Contact:

**WISKA India Pvt. Ltd.**

Mr. Omkar Ashar · Unit No.247/248,Raheja Tesla Industrial District II , Edison Bldg No.-1A,  
Plot No.GEN2/1/C/PART, TTC Industrial Area, MIDC, Juinagar, Navi Mumbai 400705, India

☎ +91-22-4967-1438 · ☎ +91-22-4967-1439 · o.ashar@wiska.in · www.wiska.in

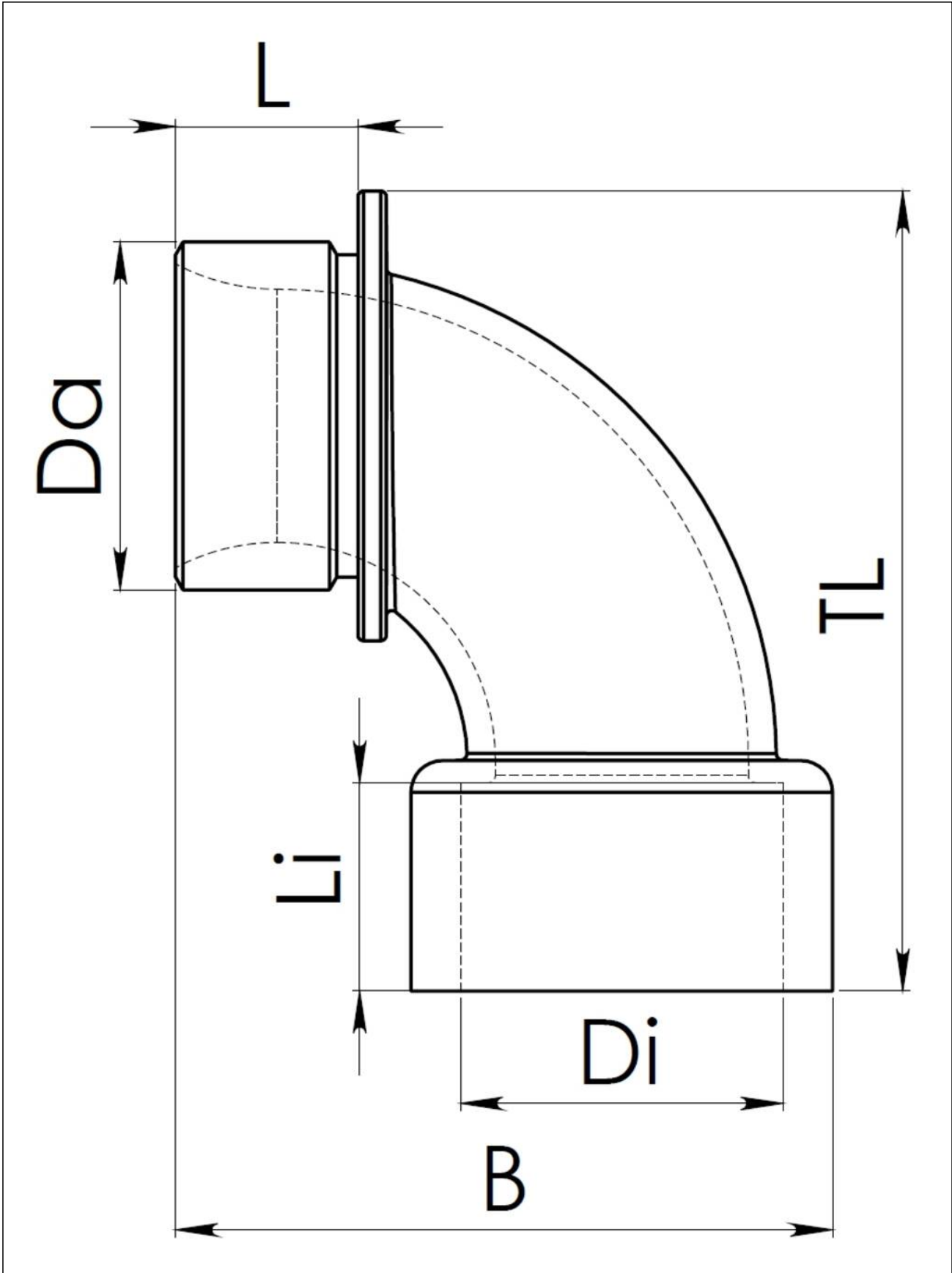

Your Contact:

**WISKA India Pvt. Ltd.**

Mr. Omkar Ashar · Unit No.247/248,Raheja Tesla Industrial District II , Edison Bldg No.-1A,  
Plot No.GEN2/1/C/PART, TTC Industrial Area, MIDC, Juinagar, Navi Mumbai 400705, India

☎ +91-22-4967-1438 · ☎ +91-22-4967-1439 · o.ashar@wiska.in · www.wiska.in