

ESKE/1-e 32 MFD 04/070

Ex- Cable gland, plastic, RAL 9005, M32, with mounted MFD

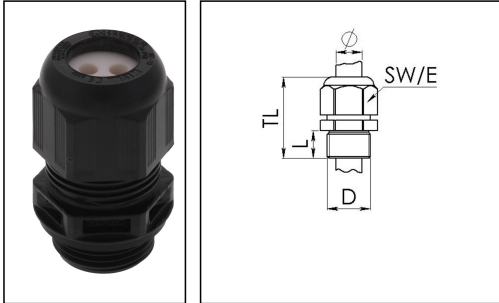

Products may differ in size, colour and appearance to those shown. If you require further information or customisation, please contact us directly.



Material cable gland	Polyamide
Material sealing gasket	TPE, EPDM
Temp. range min	-40 °C
Temp. range max	75 °C
Protection class	IP66 / IP68 (5 bar 30 min)
Type of protection	Ex eb, Ex tb
Ex-Certificate	ATEX, IECEx
Glow wire test	750 °C
Thread type	M
Ø Connection thread D	32
Lead	1,5
Length screw-in thread L	12 mm
Ø cable diameter min	6,3 mm
Ø cable diameter max	7 mm
Number of cable entries	4
Key width SW	36 mm
Collar diameter (E)	40 mm
Total length TL	42 mm - 51 mm
Install. torques fitting	4,5 N m
Install. torques cap nut	3 N m
Equipment	Incl. connection thread gasket
Product Color	RAL 9005
Order no. RAL 9005	10110870
Type	ESKE/1-e 32 MFD 04/070
Packing unit	25

Your Contact:

WISKA India Pvt. Ltd.

Mr. Omkar Ashar · Unit No.247/248,Raheja Tesla Industrial District II , Edison Bldg No.-1A,
Plot No.GEN2/1/C/PART, TTC Industrial Area, MIDC, Juinagar, Navi Mumbai 400705, India

☎ +91-22-4967-1438 · ☎ +91-22-4967-1439 · o.ashar@wiska.in · www.wiska.in

EAN number	4007686261790
Tariff number	39269097
ETIM-Classification	EC000441

Recommended accessories



EMUG 32 BK	10061784
-------------------	----------

12.05.2026

Your Contact:

WISKA India Pvt. Ltd.

Mr. Omkar Ashar · Unit No.247/248,Raheja Tesla Industrial District II , Edison Bldg No.-1A,
Plot No.GEN2/1/C/PART, TTC Industrial Area, MIDC, Juinagar, Navi Mumbai 400705, India

 +91-22-4967-1438 ·  +91-22-4967-1439 · o.ashar@wiska.in · www.wiska.in



Your Contact:

WISKA India Pvt. Ltd.

Mr. Omkar Ashar · Unit No.247/248,Raheja Tesla Industrial District II , Edison Bldg No.-1A,
Plot No.GEN2/1/C/PART, TTC Industrial Area, MIDC, Juinagar, Navi Mumbai 400705, India

☎ +91-22-4967-1438 · ☎ +91-22-4967-1439 · o.ashar@wiska.in · www.wiska.in

Other technical data on request / subject to change without notice