

## 4010-2x16-230-2-CC

LED multi-purpose luminaire 4010, 2x16W, 230V, plastic, IP66/67

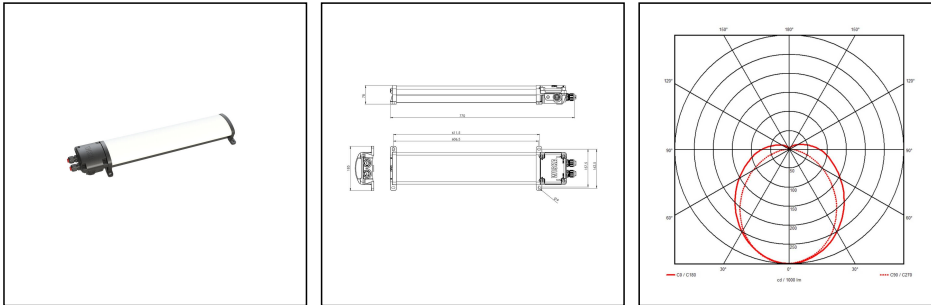

Products may differ in size, colour and appearance to those shown. If you require further information or customisation, please contact us directly.



<b>WISKA-Order no.</b>	10111891
<b>Type</b>	4010-2x16-230-2-CC
<b>Material</b>	Polycarbonate
<b>Material globe/diffuser</b>	Polycarbonate
<b>Globe colour</b>	Opal
<b>Wattage</b>	32 W
<b>Power<sup>^</sup></b>	2 x 16 W
<b>Voltage</b>	230 V
<b>Voltage min. (V)</b>	220 V
<b>Voltage max. (V)</b>	240 V
<b>Type of Voltage</b>	AC
<b>Frequence</b>	50/60 Hz
<b>Protection class</b>	IP66 / IP67
<b>Operational areas</b>	Indoor / Outdoor
<b>Temp. range min</b>	-25 °C
<b>Temp. range max</b>	50 °C
<b>Impact resistance</b>	IK10
<b>Lightsource</b>	LED
<b>Lightsource incl.</b>	Yes
<b>Colour temperature</b>	4000 K
<b>Luminous flux</b>	4800 lm
<b>Rated Lifetime</b>	L70/B10 @Ta +45 °C
<b>System Lifetime</b>	100000 h
<b>Material cable gland</b>	Polyamide
<b>Type of cable gland</b>	M 25 x 1,5

Your Contact:

WISKA India Pvt. Ltd.

Mr. Omkar Ashar · Unit No.247/248,Raheja Tesla Industrial District II , Edison Bldg No.-1A,  
Plot No.GEN2/1/C/PART, TTC Industrial Area, MIDC, Juinagar, Navi Mumbai 400705, India

+91-22-4967-1438 · +91-22-4967-1439 · o.ashar@wiska.in · www.wiska.in

<b>Ø cable diameter min</b>	9 mm
<b>Ø cable diameter max</b>	17 mm
<b>External dimensions LxWxH</b>	770x185x78mm
<b>Weight</b>	2,2 kg
<b>Colour</b>	Black
<b>Mounting</b>	Surface mounting, Wall, Ceiling

## Recommended accessories

<b>Adapterprofile MPL 36W - 4010 16W</b>	22001515
--	----------

17.06.2026

Your Contact:

**WISKA India Pvt. Ltd.**

Mr. Omkar Ashar · Unit No.247/248,Raheja Tesla Industrial District II , Edison Bldg No.-1A,  
Plot No.GEN2/1/C/PART, TTC Industrial Area, MIDC, Juinagar, Navi Mumbai 400705, India

☎ +91-22-4967-1438 · ☎ +91-22-4967-1439 · o.ashar@wiska.in · www.wiska.in

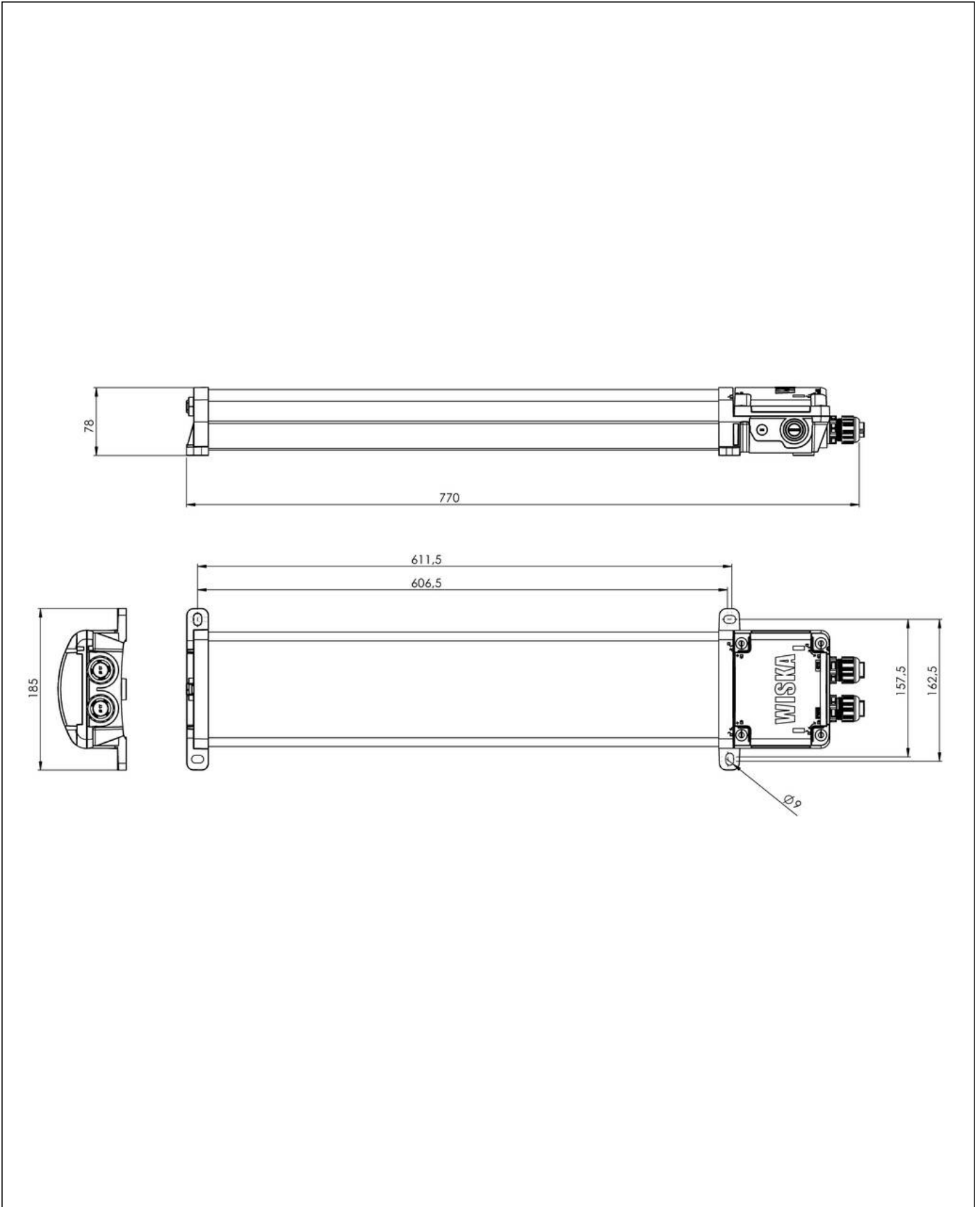

Your Contact:

**WISKA India Pvt. Ltd.**

Mr. Omkar Ashar · Unit No.247/248,Raheja Tesla Industrial District II , Edison Bldg No.-1A,  
Plot No.GEN2/1/C/PART, TTC Industrial Area, MIDC, Juinagar, Navi Mumbai 400705, India

☎ +91-22-4967-1438 · ☎ +91-22-4967-1439 · o.ashar@wiska.in · www.wiska.in

Other technical data on request / subject to change without notice

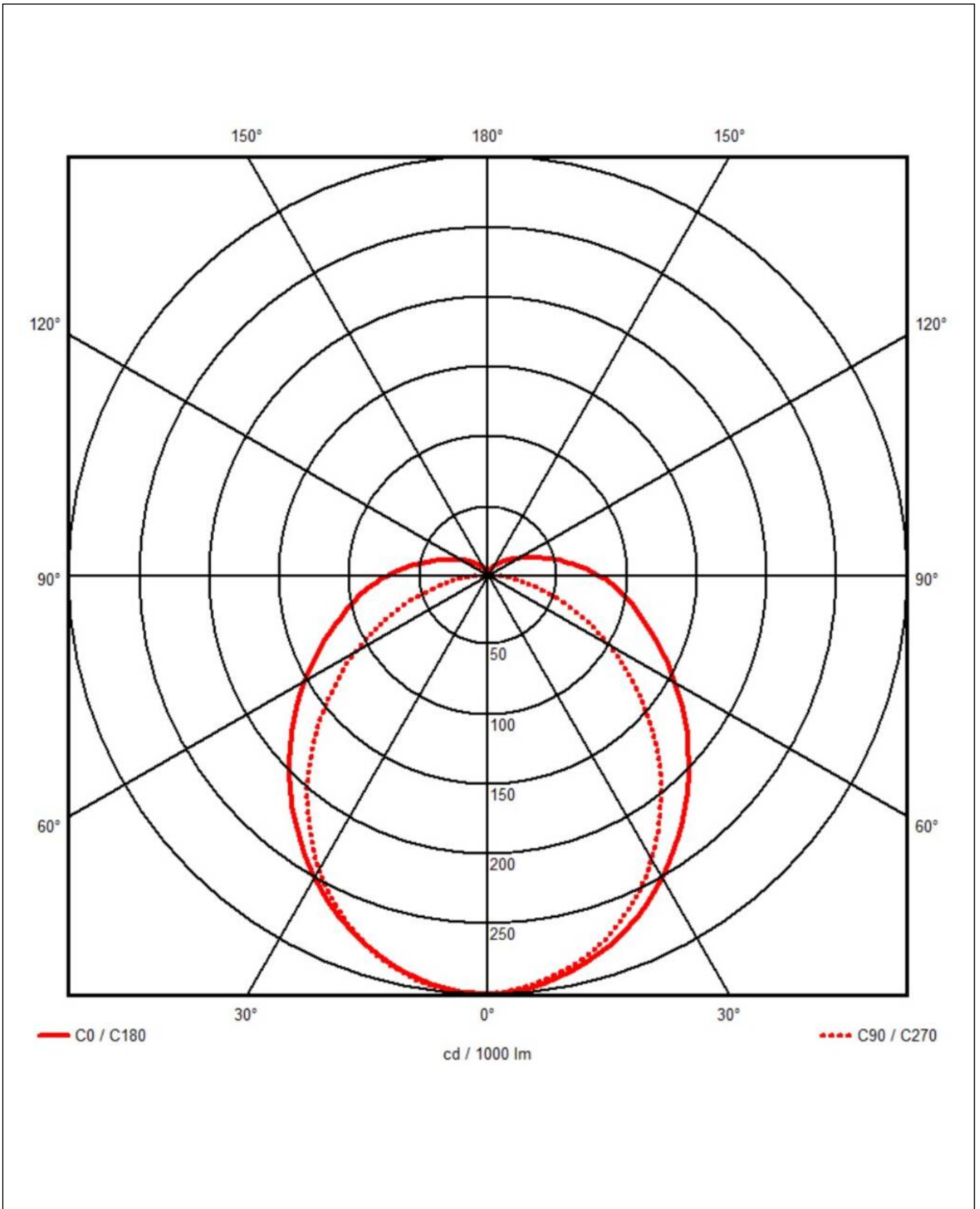

Your Contact:

**WISKA India Pvt. Ltd.**

Mr. Omkar Ashar · Unit No.247/248,Raheja Tesla Industrial District II , Edison Bldg No.-1A,  
Plot No.GEN2/1/C/PART, TTC Industrial Area, MIDC, Juinagar, Navi Mumbai 400705, India

☎ +91-22-4967-1438 · ☎ +91-22-4967-1439 · o.ashar@wiska.in · www.wiska.in

Other technical data on request / subject to change without notice