

TFT19/HD/CONS/IEC60945/MMD

TFT Monitor 19", MMD

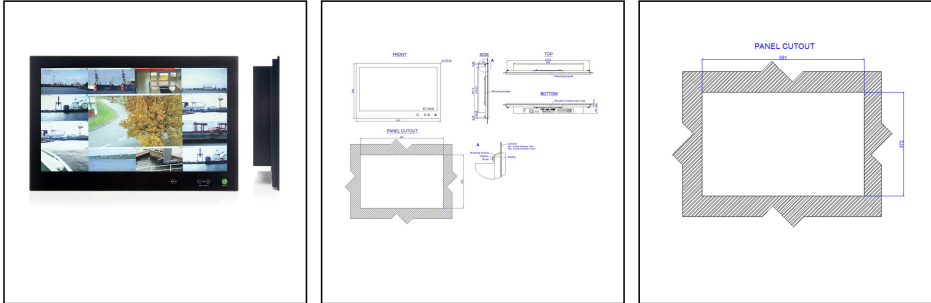

Products may differ in size, colour and appearance to those shown. If you require further information or customisation, please contact us directly.



Type	TFT19/HD/CONS/IEC60945/MMD
WISKA-Order no.	10112547
Protection class	IP66
Temp. range min	-15 °C
Temp. range max	55 °C
Humidity	95 %
Operational areas	ECR/CCR/Wheelhouse, Indoor
Range of use	IEC 60945
Mounting	Recessed mounting
Colour	Black
Resolution	1280x1024
TFT size	19"
Light intensity	350 cd/m ²
Contrast Ratio	1500:1
Aspect Ratio	5:4
CCTV add-on	Dimming (100%), Option: Desk bracket, Option: Wall bracket
Port	HDMI, Display Port
Type of Voltage	AC
Frequence	50/60 Hz
Wattage	75 W
Weight	8,1 kg
Tariff number	85285291

Remarks:

TFT Monitor 19", MMD, console mount,

Your Contact:

WISKA India Pvt. Ltd.

Mr. Omkar Ashar · Unit No.247/248,Raheja Tesla Industrial District II , Edison Bldg No.-1A,
Plot No.GEN2/1/C/PART, TTC Industrial Area, MIDC, Juinagar, Navi Mumbai 400705, India

☎ +91-22-4967-1438 · ☎ +91-22-4967-1439 · o.ashar@wiska.in · www.wiska.in

WISKA HD Serie, LED Backlight

1280x1024//25ms//1500:1/350cd/m²

100/240VAC//50/60Hz//24VDC

IP66 (front)

IEC60945 approved, DP/DVI

12.05.2026

Your Contact:

WISKA India Pvt. Ltd.

Mr. Omkar Ashar · Unit No.247/248,Raheja Tesla Industrial District II , Edison Bldg No.-1A,
Plot No.GEN2/1/C/PART, TTC Industrial Area, MIDC, Juinagar, Navi Mumbai 400705, India

 +91-22-4967-1438 ·  +91-22-4967-1439 · o.ashar@wiska.in · www.wiska.in

FRONT

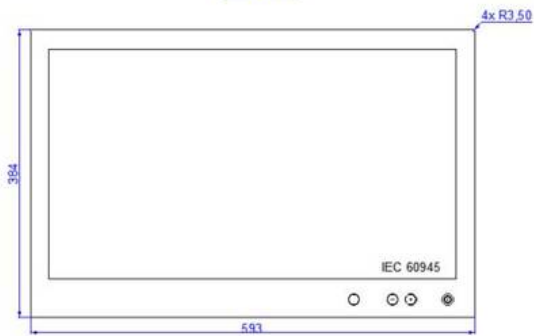

SIDE

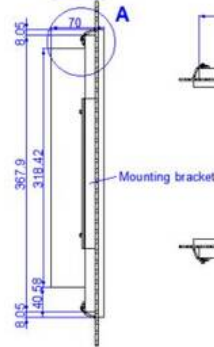

TOP

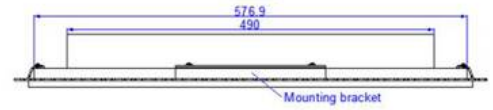

BOTTOM

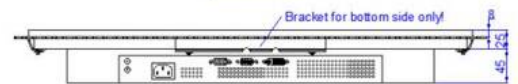

PANEL CUTOUT

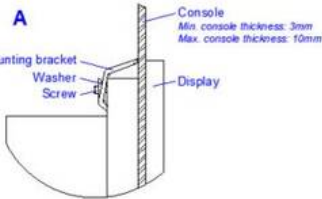
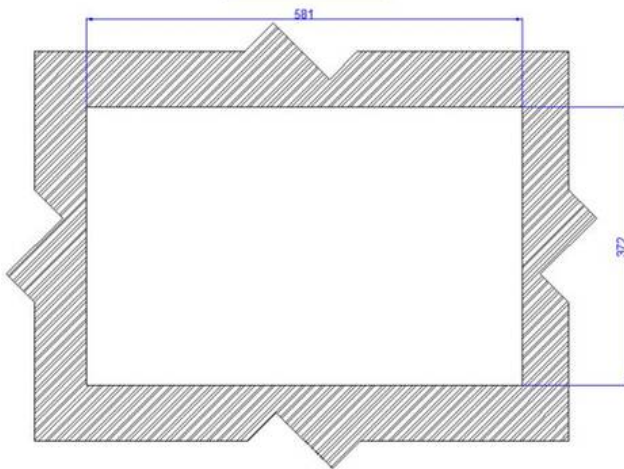

Your Contact:

WISKA India Pvt. Ltd.

Mr. Omkar Ashar · Unit No.247/248,Raheja Tesla Industrial District II , Edison Bldg No.-1A,
Plot No.GEN2/1/C/PART, TTC Industrial Area, MIDC, Juinagar, Navi Mumbai 400705, India

☎ +91-22-4967-1438 · ☎ +91-22-4967-1439 · o.ashar@wiska.in · www.wiska.in

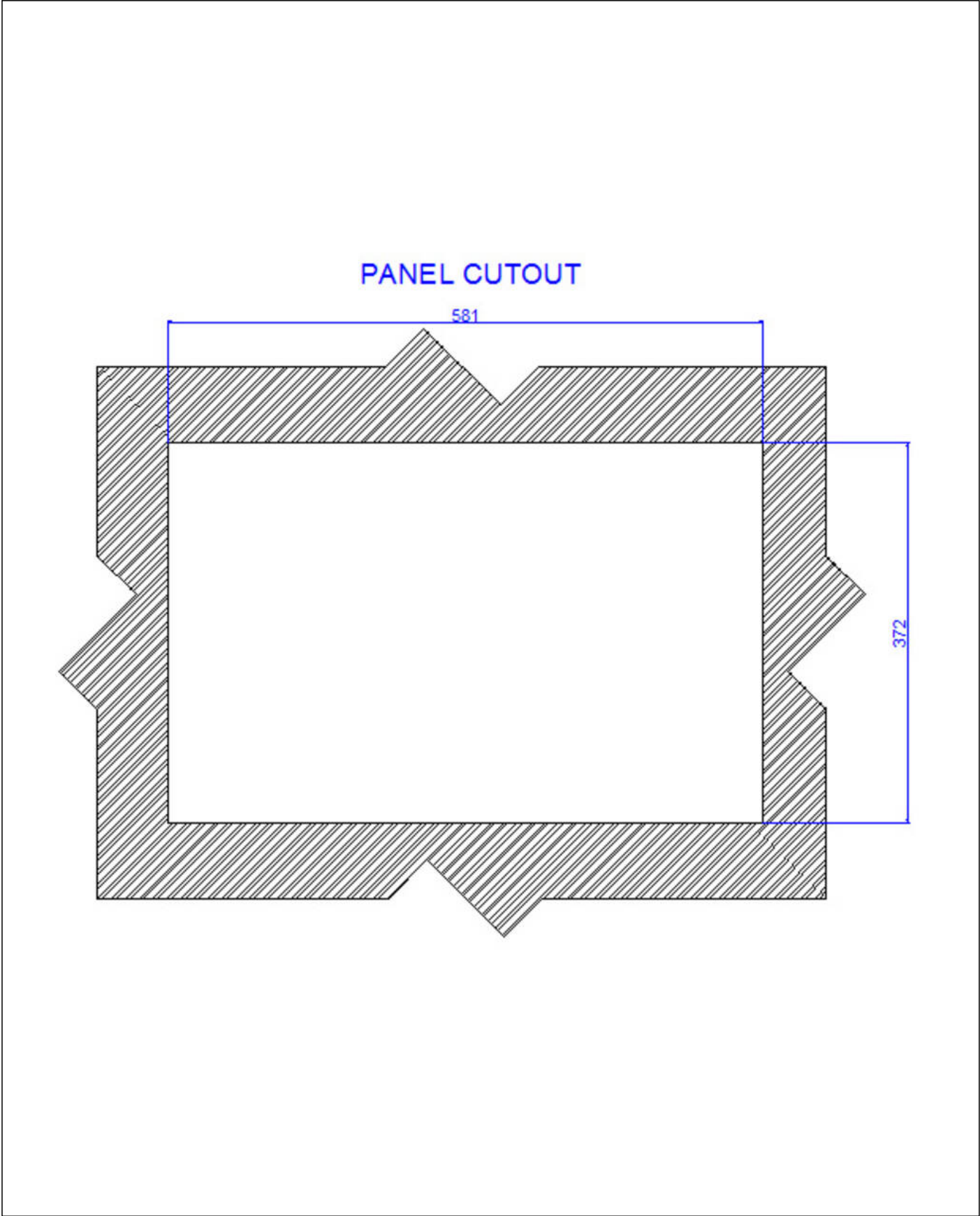

Your Contact:

WISKA India Pvt. Ltd.

Mr. Omkar Ashar · Unit No.247/248,Raheja Tesla Industrial District II , Edison Bldg No.-1A,
Plot No.GEN2/1/C/PART, TTC Industrial Area, MIDC, Juinagar, Navi Mumbai 400705, India

☎ +91-22-4967-1438 · ☎ +91-22-4967-1439 · o.ashar@wiska.in · www.wiska.in