

SBL 56/Ni

Bush, brass nickel-plated, M56

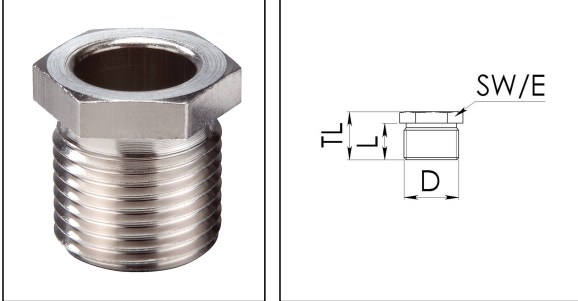

Products may differ in size, colour and appearance to those shown. If you require further information or customisation, please contact us directly.



Material	Brass nickel-plated
Temp. range min	-150 °C
Temp. range max	250 °C
Thread type	M
Ø Connection thread D	56
Lead	2
Length screw-in thread L	20 mm
Key width SW	55 mm
Collar diameter (E)	63 mm
Total length TL	28 mm
Surface	Nickel-plated
Order no. nickel-plated	30070182
Type	SBL 56/Ni
Packing unit	1
ETIM-Classification	EC000814

12.05.2026

Your Contact:

WISKA India Pvt. Ltd.

Mr. Omkar Ashar · Unit No.247/248,Raheja Tesla Industrial District II , Edison Bldg No.-1A,
Plot No.GEN2/1/C/PART, TTC Industrial Area, MIDC, Juinagar, Navi Mumbai 400705, India

☎ +91-22-4967-1438 · ☎ +91-22-4967-1439 · o.ashar@wiska.in · www.wiska.in



Your Contact:

WISKA India Pvt. Ltd.

Mr. Omkar Ashar · Unit No.247/248,Raheja Tesla Industrial District II , Edison Bldg No.-1A,
Plot No.GEN2/1/C/PART, TTC Industrial Area, MIDC, Juinagar, Navi Mumbai 400705, India

☎ +91-22-4967-1438 · ☎ +91-22-4967-1439 · o.ashar@wiska.in · www.wiska.in