

## SBK 45/Ni

Bush, brass nickel-plated, M45

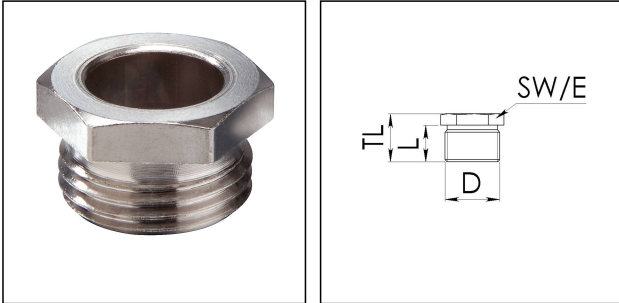

Products may differ in size, colour and appearance to those shown. If you require further information or customisation, please contact us directly.



<b>Material</b>	Brass nickel-plated
<b>Temp. range min</b>	-150 °C
<b>Temp. range max</b>	250 °C
<b>Thread type</b>	M
<b>Ø Connection thread D</b>	45
<b>Lead</b>	2
<b>Length screw-in thread L</b>	12 mm
<b>Key width SW</b>	46 mm
<b>Collar diameter (E)</b>	53 mm
<b>Total length TL</b>	19 mm
<b>Surface</b>	Nickel-plated
<b>Order no. nickel-plated</b>	30071069
<b>Type</b>	SBK 45/Ni
<b>Packing unit</b>	1
<b>ETIM-Classification</b>	EC000814

12.05.2026

Your Contact:

**WISKA India Pvt. Ltd.**

Mr. Omkar Ashar · Unit No.247/248,Raheja Tesla Industrial District II , Edison Bldg No.-1A,  
Plot No.GEN2/1/C/PART, TTC Industrial Area, MIDC, Juinagar, Navi Mumbai 400705, India

☎ +91-22-4967-1438 · ☎ +91-22-4967-1439 · o.ashar@wiska.in · www.wiska.in



Your Contact:

**WISKA India Pvt. Ltd.**

Mr. Omkar Ashar · Unit No.247/248,Raheja Tesla Industrial District II , Edison Bldg No.-1A,  
Plot No.GEN2/1/C/PART, TTC Industrial Area, MIDC, Juinagar, Navi Mumbai 400705, India

☎ +91-22-4967-1438 · ☎ +91-22-4967-1439 · o.ashar@wiska.in · www.wiska.in