

SBL 36/Ni

Bush, brass nickel-plated, M36

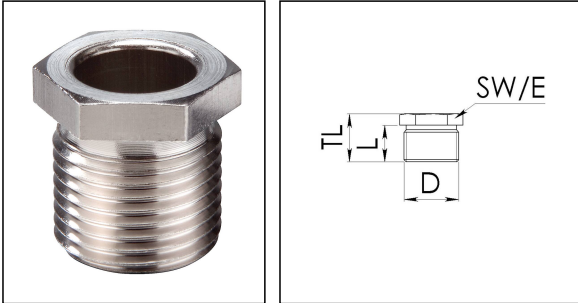

Products may differ in size, colour and appearance to those shown. If you require further information or customisation, please contact us directly.



| | |
|---------------------------------|---------------------|
| Material | Brass nickel-plated |
| Temp. range min | -150 °C |
| Temp. range max | 250 °C |
| Thread type | M |
| Ø Connection thread D | 36 |
| Lead | 2 |
| Length screw-in thread L | 19 mm |
| Key width SW | 36 mm |
| Collar diameter (E) | 41 mm |
| Total length TL | 25 mm |
| Surface | Nickel-plated |
| Order no. nickel-plated | 30071080 |
| Type | SBL 36/Ni |
| Packing unit | 1 |
| ETIM-Classification | EC000814 |

12.05.2026

Your Contact:

WISKA India Pvt. Ltd.

Mr. Omkar Ashar · Unit No.247/248,Raheja Tesla Industrial District II , Edison Bldg No.-1A,
Plot No.GEN2/1/C/PART, TTC Industrial Area, MIDC, Juinagar, Navi Mumbai 400705, India

☎ +91-22-4967-1438 · ☎ +91-22-4967-1439 · o.ashar@wiska.in · www.wiska.in



Your Contact:

WISKA India Pvt. Ltd.

Mr. Omkar Ashar · Unit No.247/248,Raheja Tesla Industrial District II , Edison Bldg No.-1A,
Plot No.GEN2/1/C/PART, TTC Industrial Area, MIDC, Juinagar, Navi Mumbai 400705, India

☎ +91-22-4967-1438 · ☎ +91-22-4967-1439 · o.ashar@wiska.in · www.wiska.in