

Rocker switch 7228452 - SE

Rocker switch, aluminium, RAL 7032, IP67

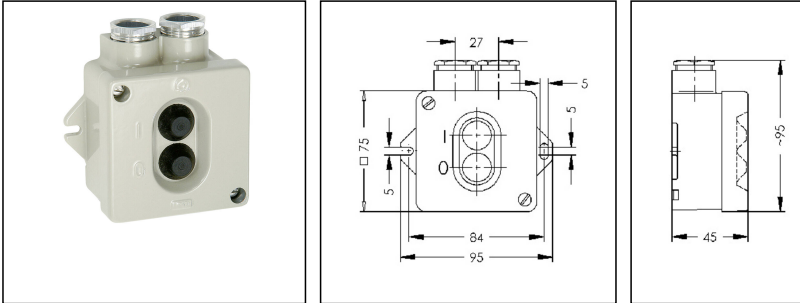

Products may differ in size, colour and appearance to those shown. If you require further information or customisation, please contact us directly.



WISKA-Order no.	50045342
Type	Rocker switch 7228452 - SE
Voltage	250 V
Current	16 A
Protection class	IP67
Material	Aluminium
Using for cable gland	
Type of cable gland	PG 16
Mounting	Surface mounting
Temp. range min	-30 °C
Temp. range max	90 °C
Type of switch	On-Off, 2-pole
Colour	RAL 7032
Weight	0,25 kg
Equipment	Aluminium pressure screws PG16
Tariff number	85363010

23.05.2026

Your Contact:

WISKA India Pvt. Ltd.

Mr. Omkar Ashar · Unit No.247/248,Raheja Tesla Industrial District II , Edison Bldg No.-1A,
Plot No.GEN2/1/C/PART, TTC Industrial Area, MIDC, Juinagar, Navi Mumbai 400705, India

☎ +91-22-4967-1438 · ☎ +91-22-4967-1439 · o.ashar@wiska.in · www.wiska.in

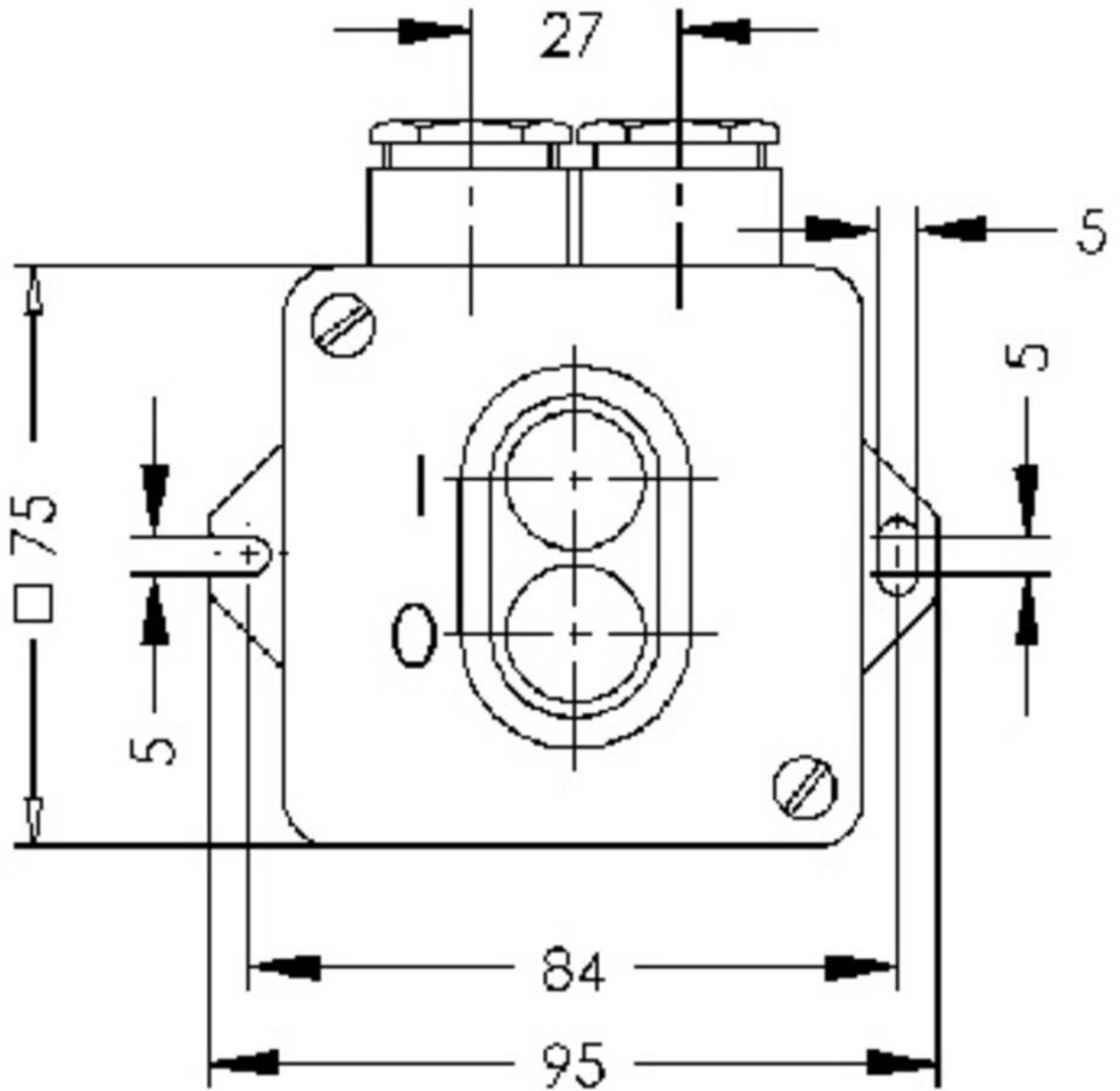

Your Contact:

WISKA India Pvt. Ltd.

Mr. Omkar Ashar · Unit No.247/248, Raheja Tesla Industrial District II, Edison Bldg No.-1A,
Plot No.GEN2/1/C/PART, TTC Industrial Area, MIDC, Juinagar, Navi Mumbai 400705, India

☎ +91-22-4967-1438 · ☎ +91-22-4967-1439 · o.ashar@wiska.in · www.wiska.in

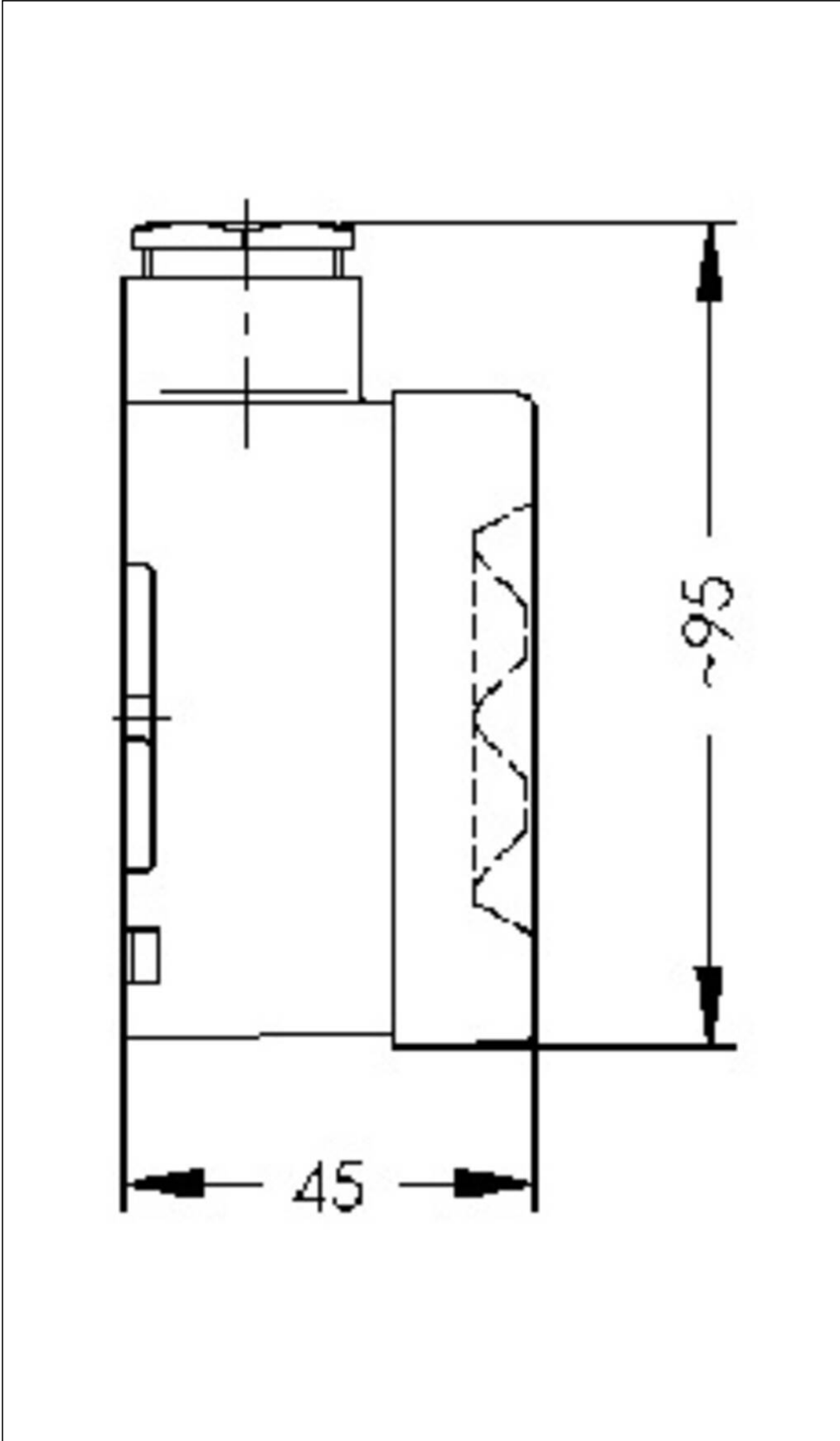

Your Contact:

WISKA India Pvt. Ltd.

Mr. Omkar Ashar · Unit No.247/248,Raheja Tesla Industrial District II , Edison Bldg No.-1A,
Plot No.GEN2/1/C/PART, TTC Industrial Area, MIDC, Juinagar, Navi Mumbai 400705, India

☎ +91-22-4967-1438 · ☎ +91-22-4967-1439 · o.ashar@wiska.in · www.wiska.in