

Schuko double socket 7229422 - SE

Schuko double socket 16A 250V, aluminium, RAL 7032, IP44

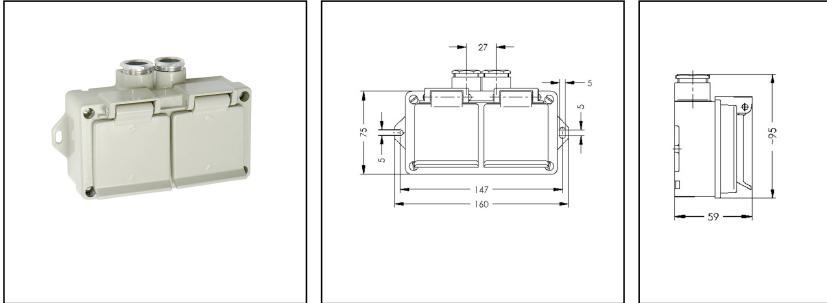

Products may differ in size, colour and appearance to those shown. If you require further information or customisation, please contact us directly.



WISKA-Order no.	50045472
Type	Schuko double socket 7229422 - SE
Voltage	250 V
Current	16 A
Protection class	IP44
Material	Cast aluminium
Using for cable gland	
Type of cable gland	PG16 / 12-14mm
External dimensions LxWxH	160x75x59mm
Socket insert	SCHUKO
Terminals/poles	2-pole + E
Weight	0,5 kg
Colour	RAL 7032
Mounting	Surface mounting
Variations	on request
Tariff number	85366990

Equipment:

- Aluminium pressure screws
- Hinged flip cover
- Stainless steel spring

Spare parts

P924000 Schuko socket insert - SE	50046012
--	----------

23.05.2026

Your Contact:

WISKA India Pvt. Ltd.

Mr. Omkar Ashar · Unit No.247/248,Raheja Tesla Industrial District II , Edison Bldg No.-1A,
Plot No.GEN2/1/C/PART, TTC Industrial Area, MIDC, Juinagar, Navi Mumbai 400705, India

☎ +91-22-4967-1438 · ☎ +91-22-4967-1439 · o.ashar@wiska.in · www.wiska.in

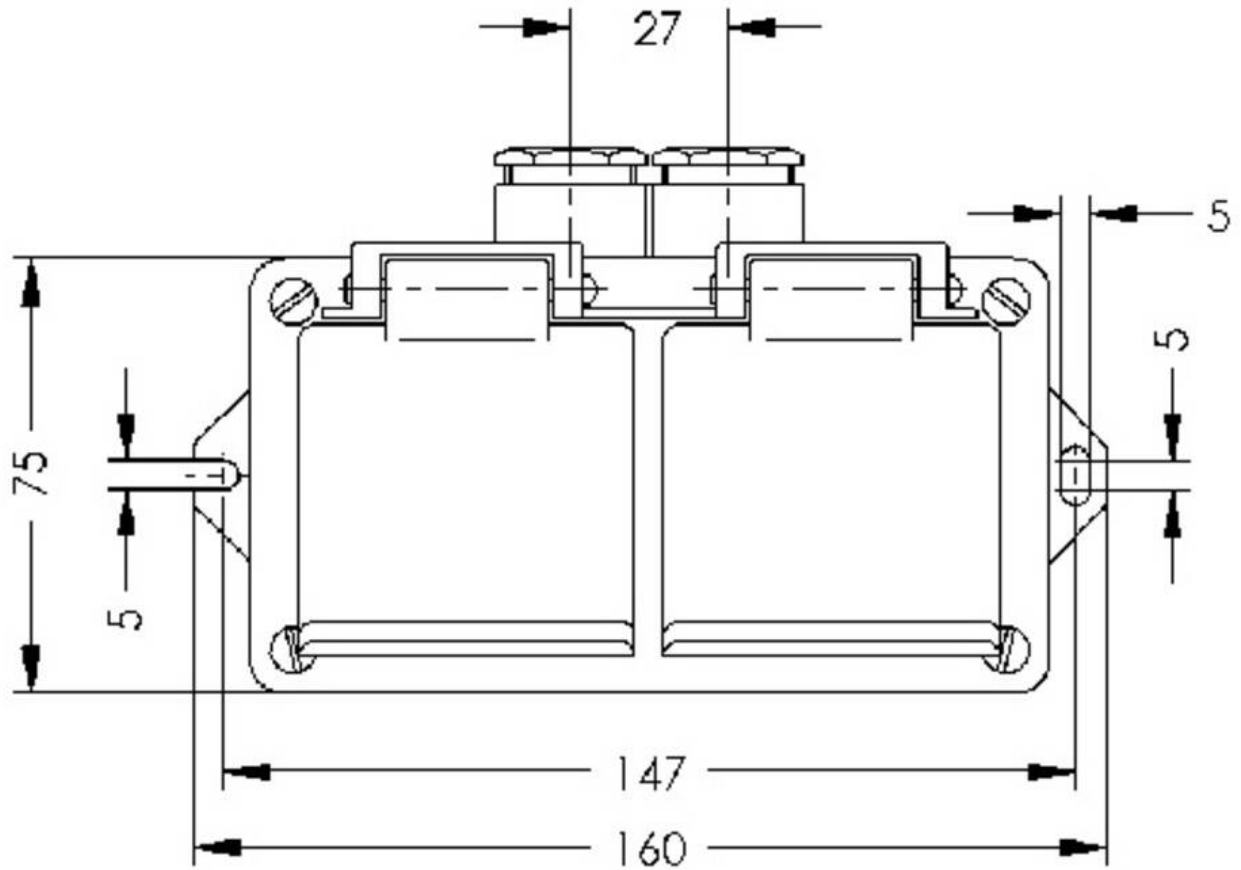

Your Contact:

WISKA India Pvt. Ltd.

Mr. Omkar Ashar · Unit No.247/248, Raheja Tesla Industrial District II, Edison Bldg No.-1A,
Plot No.GEN2/1/C/PART, TTC Industrial Area, MIDC, Juinagar, Navi Mumbai 400705, India

☎ +91-22-4967-1438 · ☎ +91-22-4967-1439 · o.ashar@wiska.in · www.wiska.in

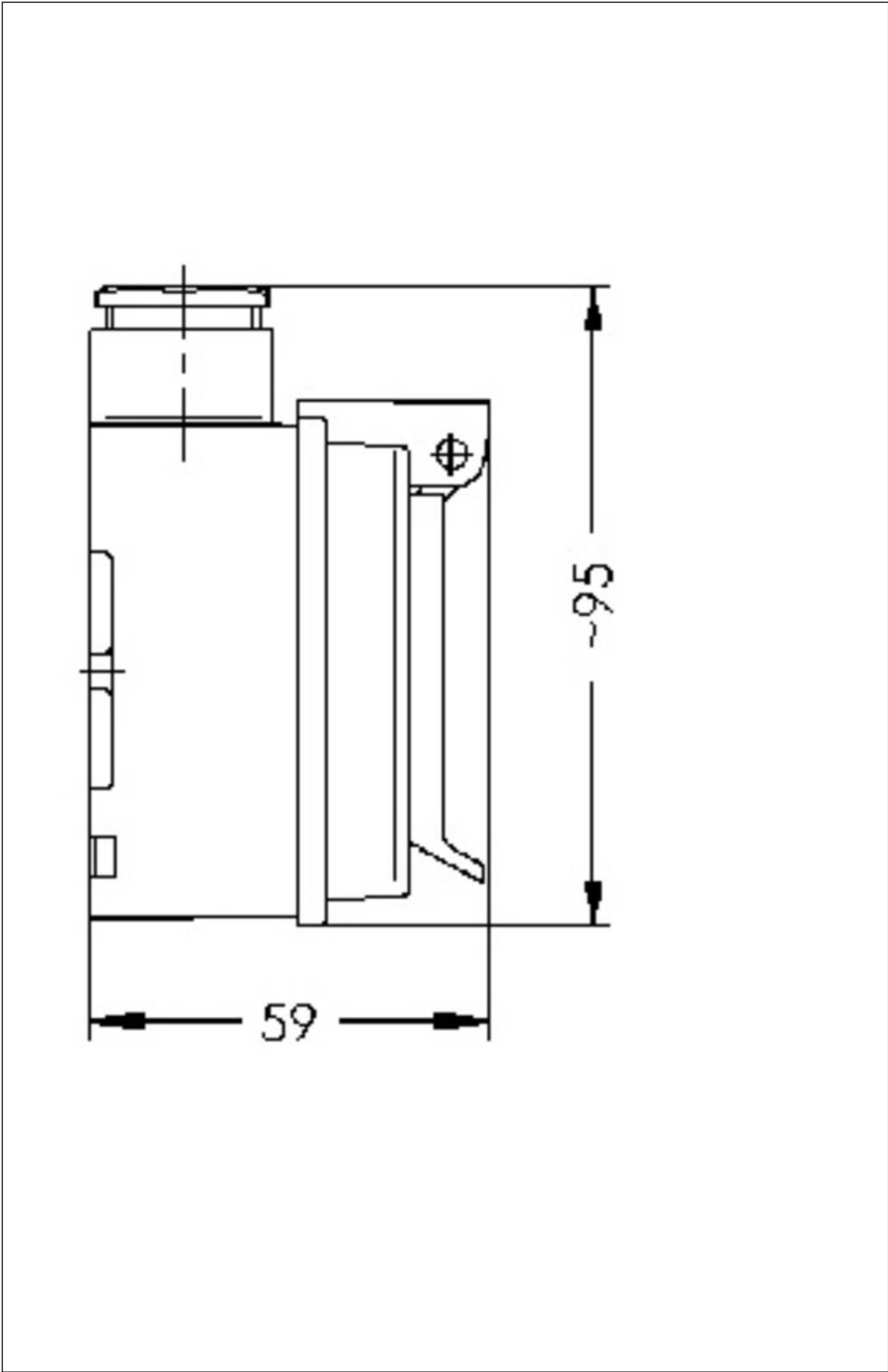

Your Contact:

WISKA India Pvt. Ltd.

Mr. Omkar Ashar · Unit No.247/248,Raheja Tesla Industrial District II , Edison Bldg No.-1A,
Plot No.GEN2/1/C/PART, TTC Industrial Area, MIDC, Juinagar, Navi Mumbai 400705, India

☎ +91-22-4967-1438 · ☎ +91-22-4967-1439 · o.ashar@wiska.in · www.wiska.in