

FD 50 BK

FLIP cable grommet, EPDM, RAL 9005, M50

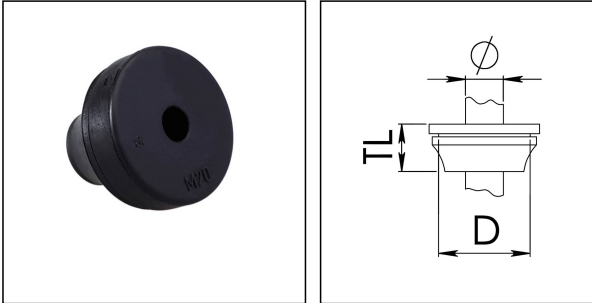

Products may differ in size, colour and appearance to those shown. If you require further information or customisation, please contact us directly.



Material	EPDM
Temp. range min	-40 °C
Temp. range max	110 °C
Protection class	IP66 / IP67
Thread type	M
Ø Connection thread D	50
Ø cable diameter min	27 mm
Ø cable diameter max	35 mm
Total length TL	35 mm
Ø Drilling	50 mm - 51 mm
Wall thickness S	1 mm - 4 mm
Product Color	RAL 9005
Order no. RAL 9005	50062897
Type	FD 50 BK
Packing unit	10
EAN number	4007685628976
Tariff number	40169300
ETIM-Classification	EC000451

27.06.2026

Your Contact:

WISKA India Pvt. Ltd.

Mr. Omkar Ashar · Unit No.247/248,Raheja Tesla Industrial District II , Edison Bldg No.-1A,
Plot No.GEN2/1/C/PART, TTC Industrial Area, MIDC, Juinagar, Navi Mumbai 400705, India

☎ +91-22-4967-1438 · ☎ +91-22-4967-1439 · o.ashar@wiska.in · www.wiska.in

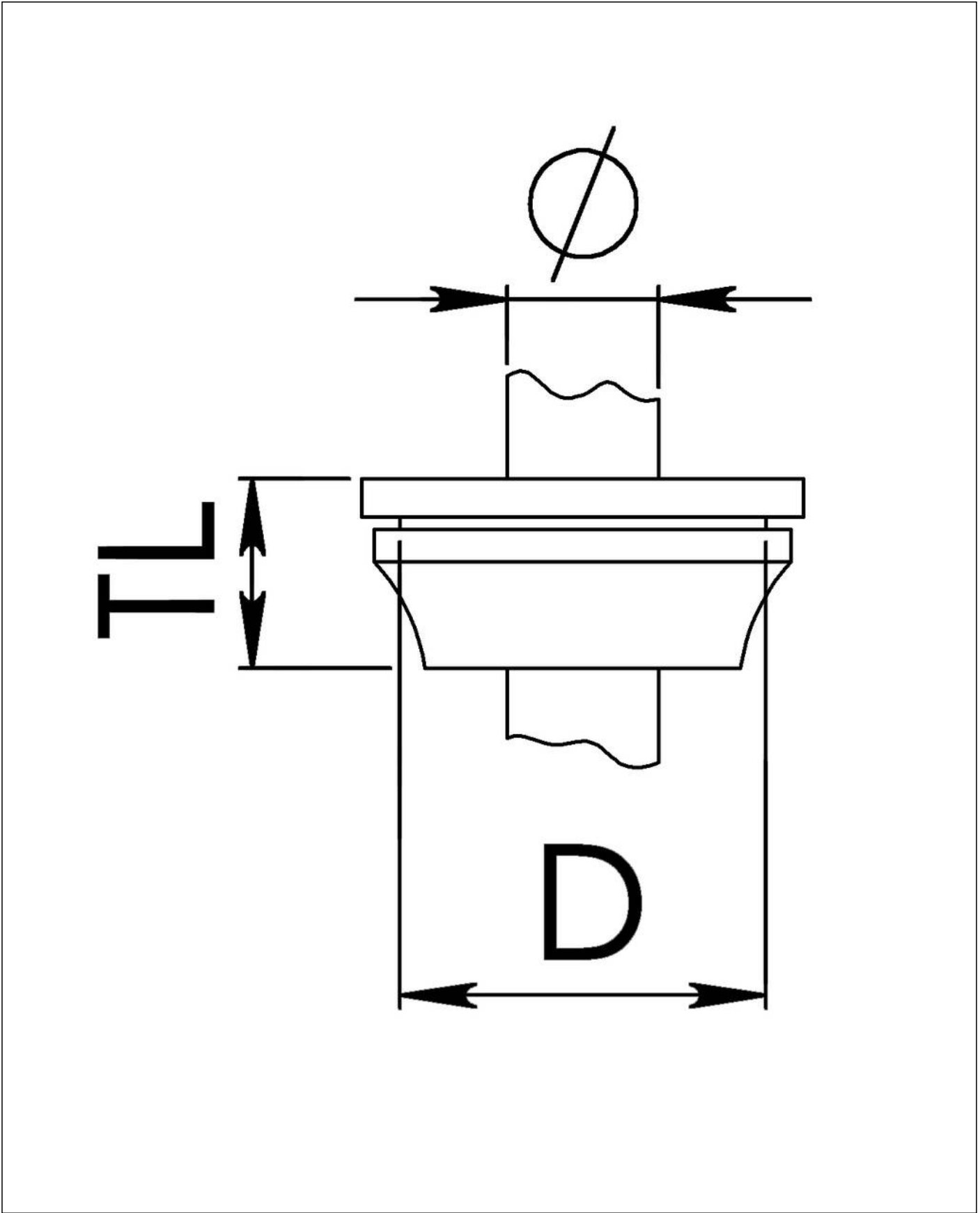

Your Contact:
WISKA India Pvt. Ltd.
Mr. Omkar Ashar · Unit No.247/248,Raheja Tesla Industrial District II , Edison Bldg No.-1A,
Plot No.GEN2/1/C/PART, TTC Industrial Area, MIDC, Juinagar, Navi Mumbai 400705, India
☎ +91-22-4967-1438 · ☎ +91-22-4967-1439 · o.ashar@wiska.in · www.wiska.in