

OSAJ 40 / M20(M)*M40(F)

Ex d enlargement adaptor, brass nickel-plated, M20-M40

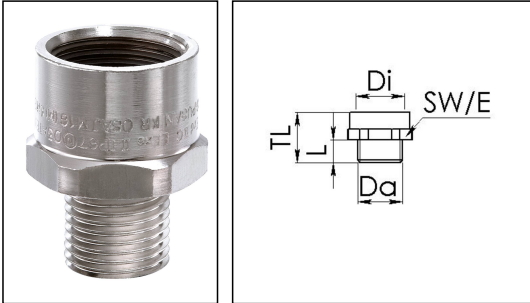

Products may differ in size, colour and appearance to those shown. If you require further information or customisation, please contact us directly.



Material	Brass nickel-plated
Temp. range min	-60 °C
Temp. range max	110 °C
Protection class	IP66 / IP67
Type of protection	Ex eb, Ex db, Ex tb
Ex-Certificate	IECEX, ATEX
Thread type outer	M
Ø outer thread	20
Lead outer	1,5
Thread type inner	M
Ø inner thread	40
Lead inner	1,5
Length screw-in thread L	15 mm
Key width SW	48 mm
Collar diameter (E)	51 mm
Total length TL	37 mm
Surface	Nickel-plated
Order no. nickel-plated	50065692
Type	OSAJ 40 / M20(M)*M40(F)
Packing unit	1
Tariff number	74198090
EAN number	4007685656924
ETIM-Classification	EC000938

Your Contact:

WISKA India Pvt. Ltd.

Mr. Omkar Ashar · Unit No.247/248,Raheja Tesla Industrial District II , Edison Bldg No.-1A,
Plot No.GEN2/1/C/PART, TTC Industrial Area, MIDC, Juinagar, Navi Mumbai 400705, India

+91-22-4967-1438 · +91-22-4967-1439 · o.ashar@wiska.in · www.wiska.in

27.06.2026

Your Contact:

WISKA India Pvt. Ltd.

Mr. Omkar Ashar · Unit No.247/248,Raheja Tesla Industrial District II , Edison Bldg No.-1A,
Plot No.GEN2/1/C/PART, TTC Industrial Area, MIDC, Juinagar, Navi Mumbai 400705, India

☎ +91-22-4967-1438 · ☎ +91-22-4967-1439 · o.ashar@wiska.in · www.wiska.in



Your Contact:

WISKA India Pvt. Ltd.

Mr. Omkar Ashar · Unit No.247/248,Raheja Tesla Industrial District II , Edison Bldg No.-1A,
Plot No.GEN2/1/C/PART, TTC Industrial Area, MIDC, Juinagar, Navi Mumbai 400705, India

☎ +91-22-4967-1438 · ☎ +91-22-4967-1439 · o.ashar@wiska.in · www.wiska.in

Other technical data on request / subject to change without notice