

PL-32A-FS-230V-3P-6H-IP67-K03-C01

CEE plug 32A 230V 6h, plastic, IP67

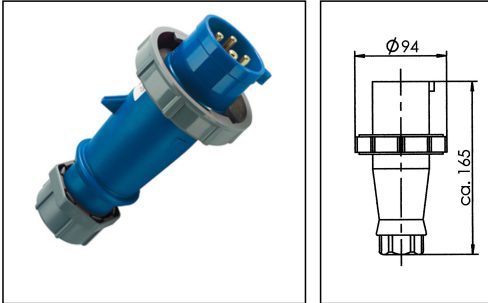

Products may differ in size, colour and appearance to those shown. If you require further information or customisation, please contact us directly.

WISKA-Order no.	50101961
Type	PL-32A-FS-230V-3P-6H-IP67-K03-C01
Material	Plastic
Current	32 A
Voltage max. (V)	230 V
Protection class	IP67
Temp. range min	-25 °C
Temp. range max	45 °C
plug insert	CEE
Clock face position	6h
Terminals/poles	2-pole + E
Ø cable diameter max	22 mm
Weight	0,23 kg
Variations	on request
Tariff number	85366990

Remarks:

Contact: standard

Connection technology: Screw terminals

one-piece housing

gland with seal gasket

bend protection and strain relief

12.05.2026

Your Contact:

WISKA India Pvt. Ltd.

Mr. Omkar Ashar · Unit No.247/248,Raheja Tesla Industrial District II , Edison Bldg No.-1A,
Plot No.GEN2/1/C/PART, TTC Industrial Area, MIDC, Juinagar, Navi Mumbai 400705, India

☎ +91-22-4967-1438 · ☎ +91-22-4967-1439 · o.ashar@wiska.in · www.wiska.in

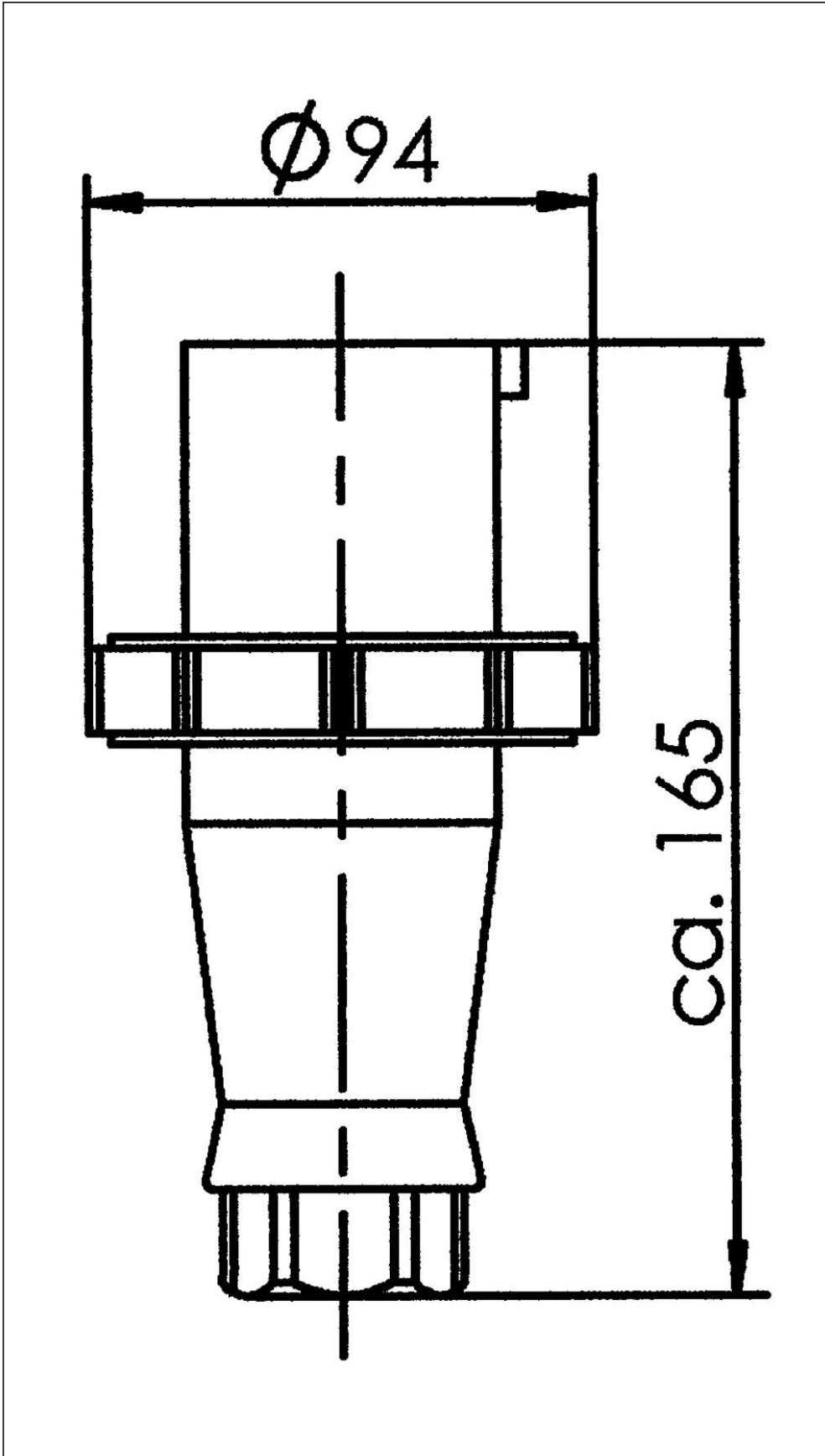

Your Contact:

WISKA India Pvt. Ltd.

Mr. Omkar Ashar · Unit No.247/248,Raheja Tesla Industrial District II , Edison Bldg No.-1A,
Plot No.GEN2/1/C/PART, TTC Industrial Area, MIDC, Juinagar, Navi Mumbai 400705, India

☎ +91-22-4967-1438 · ☎ +91-22-4967-1439 · o.ashar@wiska.in · www.wiska.in