

OS-E1UF 16 / M16

Ex d cable gland, brass nickel-plated, M16

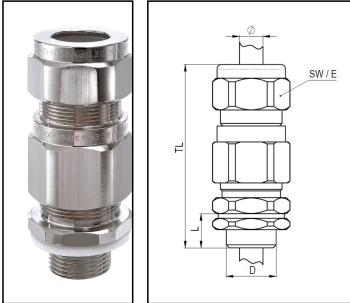

Products may differ in size, colour and appearance to those shown. If you require further information or customisation, please contact us directly.



Material cable gland	Brass nickel-plated
Material sealing gasket	Silicone
Temp. range min	-60 °C
Temp. range max	110 °C
Protection class	IP66 / IP67
Type of protection	Ex eb, Ex tb, Ex db
Ex-Certificate	IECEx, ATEX
Thread type	M
Ø Connection thread D	16
Lead	1,5
Length screw-in thread L	15 mm
Ø cable diameter min	9 mm
Ø cable diameter max	15,5 mm
Ø cable below cable shield max	5 mm - 11,5 mm
Key width SW	25 mm
Collar diameter (E)	27 mm
Total length TL	67 mm
Equipment	Incl. connection thread gasket, incl. locknut
Surface	Nickel-plated
Order no. nickel-plated	50107579
Type	OS-E1UF 16 / M16
Packing unit	1
Tariff number	74198090
EAN number	4007686137262
ETIM-Classification	EC000441

Your Contact:

WISKA India Pvt. Ltd.

Mr. Omkar Ashar · Unit No.247/248, Raheja Tesla Industrial District II , Edison Bldg No.-1A,
Plot No.GEN2/1/C/PART, TTC Industrial Area, MIDC, Juinagar, Navi Mumbai 400705, India

☎ +91-22-4967-1438 · ☎ +91-22-4967-1439 · o.ashar@wiska.in · www.wiska.in

Recommended accessories

OSSH-A-16	50065626
OSET 16 / M16	50065634

27.06.2026

Your Contact:

WISKA India Pvt. Ltd.

Mr. Omkar Ashar · Unit No.247/248,Raheja Tesla Industrial District II , Edison Bldg No.-1A,
Plot No.GEN2/1/C/PART, TTC Industrial Area, MIDC, Juinagar, Navi Mumbai 400705, India

☎ +91-22-4967-1438 · ☎ +91-22-4967-1439 · o.ashar@wiska.in · www.wiska.in

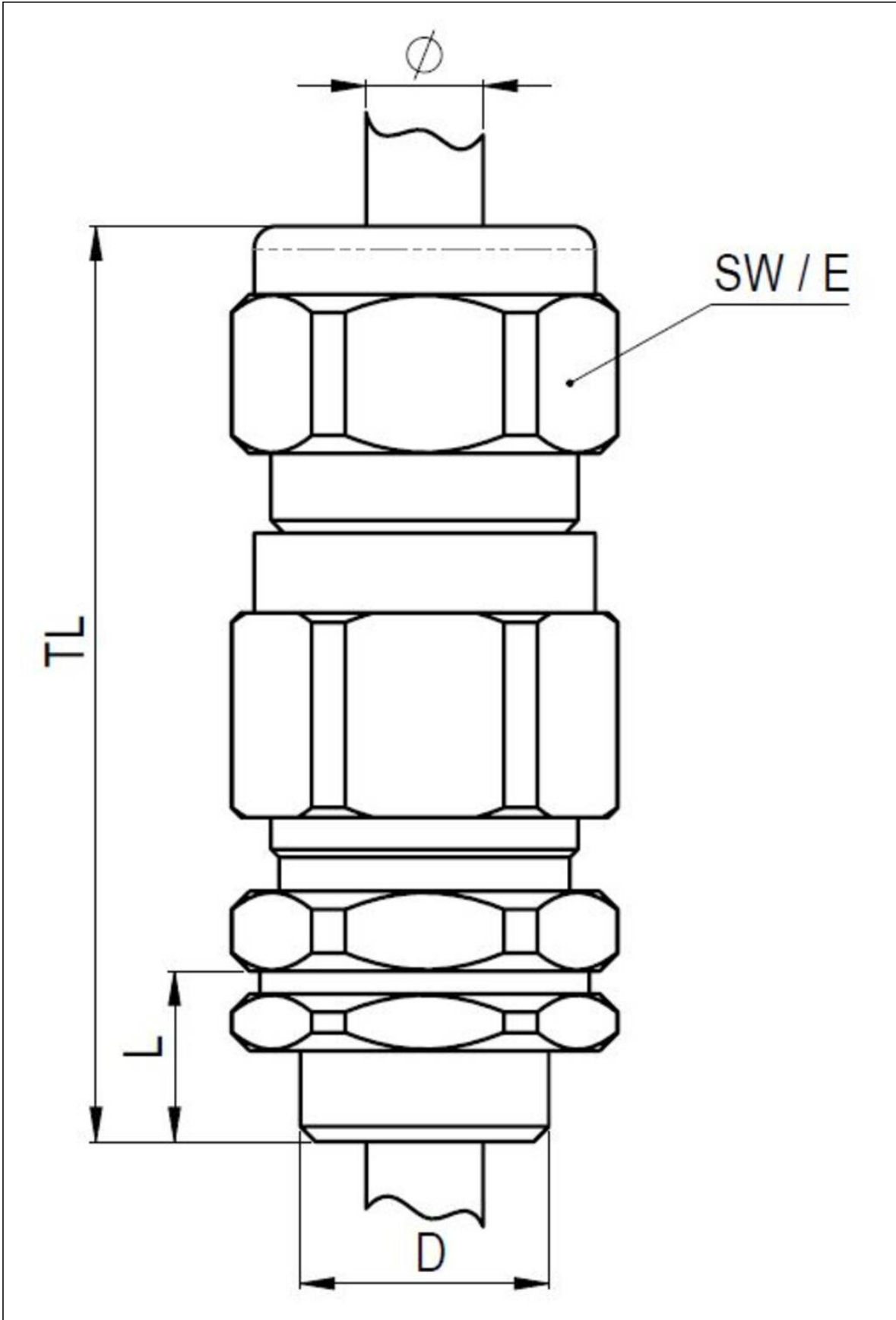

Your Contact:

WISKA India Pvt. Ltd.

Mr. Omkar Ashar · Unit No.247/248,Raheja Tesla Industrial District II , Edison Bldg No.-1A,
Plot No.GEN2/1/C/PART, TTC Industrial Area, MIDC, Juinagar, Navi Mumbai 400705, India

☎ +91-22-4967-1438 · ☎ +91-22-4967-1439 · o.ashar@wiska.in · www.wiska.in

Other technical data on request / subject to change without notice